

# RADIO *Retailing* TODAY

DECEMBER 1943

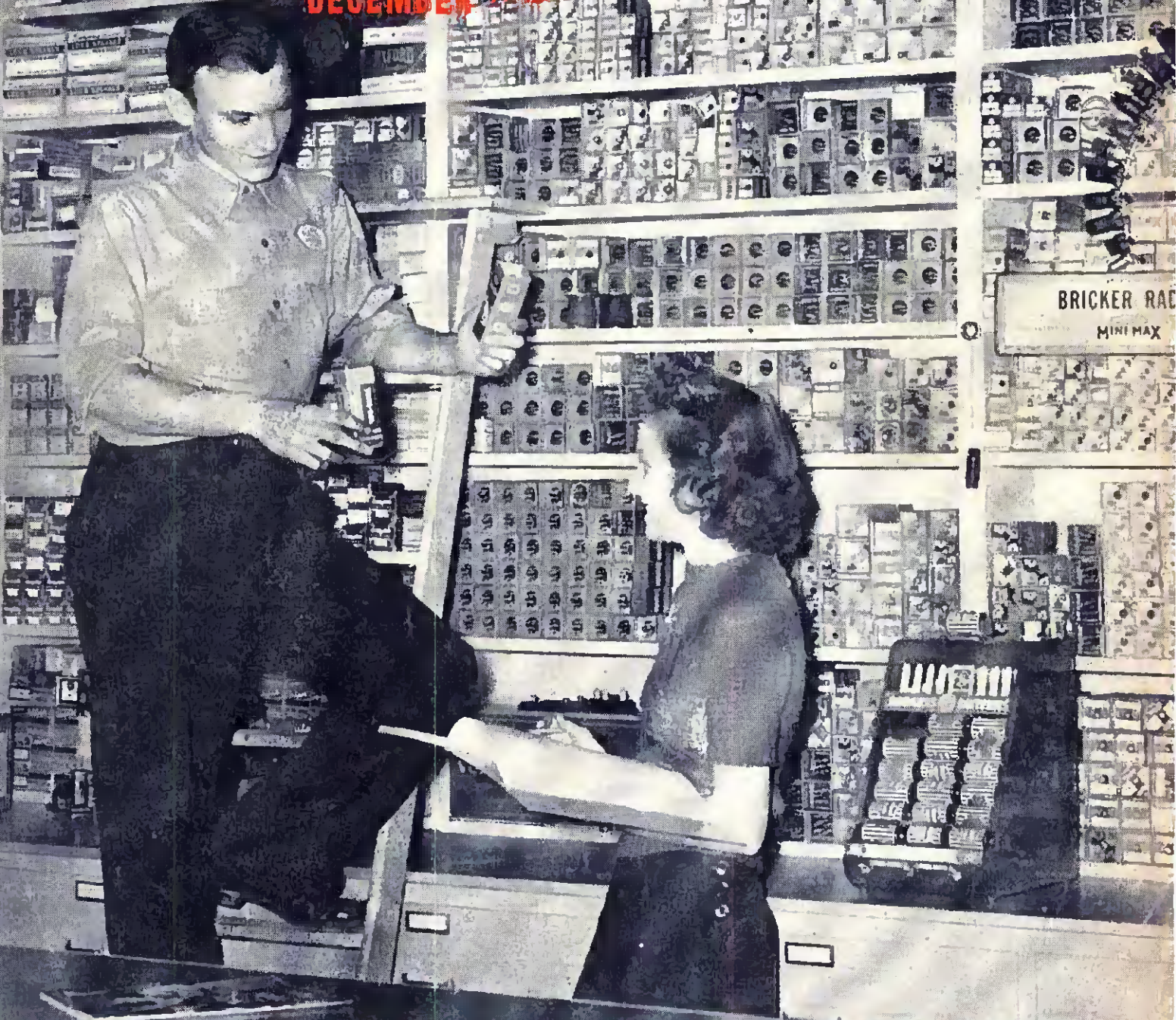

In This Issue ★ **INVENTORY POINTERS** — Radio Men in Action. Refrigerator  
Future. Radio Electronic Maintenance, Appliance  
Repairs. Record Sales Soar.

# Donate Your Scrap To The War Effort

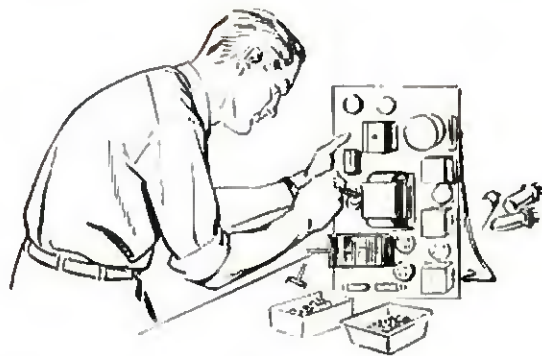

**D**onate or sell your metal scrap for the War effort. Those unused parts will help make planes, tanks and guns to beat the Axis.

But donate *wisely*. If you do not have a reasonable stock of nuts, lock washers, screws, solder lugs and similar items, strip your junk of these parts. Radio hardware will become increasingly hard to secure—but more important is the necessity of eliminating purchases of small parts which are fabricated by automatic screw machines.

The automatic screw machines of our nation are working overtime, turning out parts for War use. Don't add to this burden by discarding parts which must be repurchased in the near future. Your good common sense will tell you what to save and what to scrap.

But act now! Take apart discarded apparatus. Don't hold on to that old receiver or other assembly because it has some part you may need later. Remove the parts and sub-assemblies that have immediate definite replacement value—junk the rest to help junk the Japs.

Large quantities of bulk metal are needed immediately. Do your part!

**P. R. MALLORY & CO., Inc., INDIANAPOLIS, INDIANA**

**P. R. MALLORY & CO. Inc.**  
**MALLORY**



**Approved Precision Products**

*Majestic*

## CONTROLLED DISTRIBUTION

**Majestic's CONTROLLED DISTRIBUTION Plan** is a program of merchandising aimed at eliminating much, or all, of the grief of which cut-price, auction block tactics were an all too common symptom before the war.

**Majestic** will influence its distributors to exercise greatest care in selecting only dealers who have the ability and facility to conduct their businesses along sound, profitable lines which will prove *permanently* and *increasingly* successful.

The decision to appoint a new dealer must be made *only after* the distributor has *assured himself* that such dealer considers it *absolutely essential* to his success to maintain adequate profit margins. Thus to give expression to its over-all **PROTECTED-PROFITS PROGRAM**, **Majestic CONTROLLED DISTRIBUTION** becomes an important and necessary development. It will operate for the **GREATER GOOD** of the entire **Majestic Dealer Organization**.

*Majestic*

## PLANNED PRODUCTION

**At Majestic**, production executives will work in close co-operation with sales-minded chief executives, whose decisions regarding what and how much **Majestic** manufactures, will be based upon comprehensive and accurate size-ups of consumer demand, gained by actual personal contact on dealers' sales floors.

### **Engineering and Design**

**After** all engineering considerations have been weighed carefully in the light of latest scientific developments, the final test to be applied to any new product or design, will be the very critical appraisal of sales-minded chief executives. It is *these executives* who will *finally* determine the appearance as well as the features of **ALL** **Majestic** post-war radios. The aim of this

sales-control of engineering and design will be to avoid merchandise "backing up" on the dealers' floors, by producing *only* products and designs which careful consumer size-ups have shown to be **WHAT THE PUBLIC WANTS**.

### **Dependable Performance**

**Of** major importance to the ultimate purchaser of a radio set is its performance, not only initially but over a period of time. Great stress will be laid on this factor of dependability in the post-war **Majestic** radios. To **Majestic** dealers, dependable performance means customer satisfaction; it means less service "grief"; it means greater good-will both for the name, **Majestic**, and for all members of the **Majestic** dealer family.

**MAJESTIC RADIO & TELEVISION CORPORATION**  
2600 W. 50th Street



Chicago 32, Illinois

*Builders of the Walkie-Talkie. "Radio of The Firino Line"*

# RADIO LABORATORIES

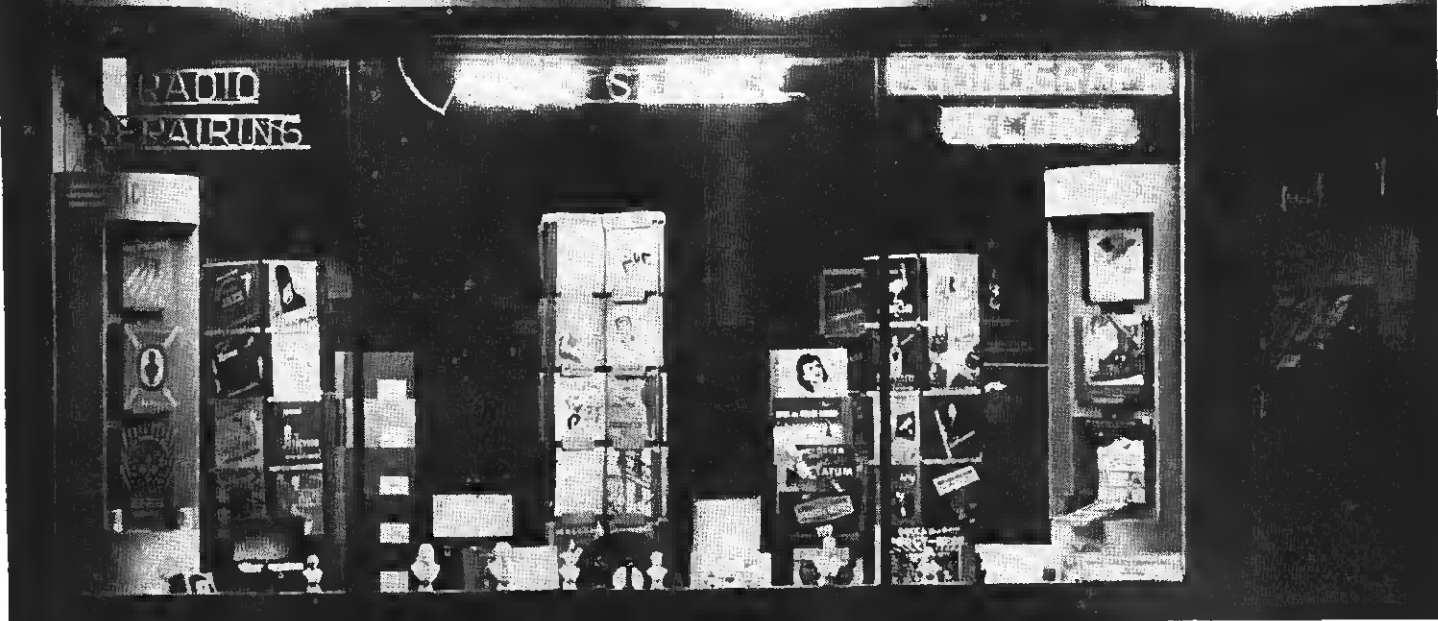

## Records to the Rescue

*They Filled in the Sales Gap for St. Paul Radio Dealer*

• "Nothing upsets morale quite so much as to be without a radio," declares H. H. Callendar, the manager of the Radio Service Laboratories, Inc., Sixth St., St. Paul, Minn. "The public wants the news. There are home boys in various fighting zones; their folks want to know how the tides of battle are turning. When their radio goes dead, they feel they have lost something vital. They must have it repaired—and quick!"

That attitude helps bring much repair business to the Radio Service Laboratories, which had a well-established repair department before Pearl Harbor.

Yet, additional repair business wasn't enough to take up the slack left by the increasing shortage of radios. To stay in business, to realize a profit, something else was necessary. And that something else was found in records.

Previously the shop had a small

record department. After consideration of ways and means to keep business coming to the shop, it was decided to greatly enlarge this department. Today it is a record center, with shelves and tables and display fixtures filled with records and record albums, and windows constantly devoted to them. Several other shops which closed and one large music house which also went out of business sold their stocks of records to the Radio Service Laboratories. New stock has been added. The sales increase in the record department is about 300%.

### **300 Per Cent Sales Jump**

"The increase in record purchases is tremendous," reports the manager, "and there is a remarkable interest in record combination players. The public is music mad. If today's interest is continued, one of the big fields for manufacturers after the war will be in the combination phonograph-radio

machines." Good news for dealers!

According to officials of this firm music lovers express a desire to see the record changers developed so that they will change records better and so that the wear on records will not be so great. They are also looking for better tone quality. These improvements, now being studied, will be sure to result in greatly increased business after the war.

### **Records Build Prospects**

Between the service department and the greatly enlarged record section, the shop is doing an excellent business—business which it believes will be held when radios are once again in production. The people who are making it a habit to buy records at the Radio Service Laboratories now, will not only continue to buy them after the war, but they will be excellent prospects for radios and combination radio-phonographs.

**"THIS YEAR, LET'S PAY THE BONUS  
IN WAR BONDS**



**... and drive even harder on the pay-roll savings plan!"**

Make War Bonds the Christmas Order of the Day. Urge your workers to make their personal Christmas gifts in the form of War Bonds—and practice what you preach! Make this a 100% War Bond Christmas—to insure future Yuletides of peace and prosperity.

Make up your own posters to spread the "War Bonds for Christmas" story across your plant. Tell the story again and again on bulletin boards, in your plant magazine, and on pay envelope stuffers.

But don't forget your basic, all-important Pay-Roll Savings Plan. How's it going, these days? Perhaps it needs a bit of stoking-up right this very minute, to hold its full head of steam against the competitive demands of the holiday season.

*Well, you're the man to stoke it!* You can't expect it to keep running indefinitely on last summer's enthusiasm. See to it that your participation percentages, and your deduction percentages, *both* end up the year at new levels.

Every month, now your Pay-Roll Savings ought to run well ahead of the preceding month. *For so many families that formerly depended on the earnings of a single worker, now enjoy the combined earnings of several.* Such family incomes are doubled, trebled, even multiplied many times.

Now's the time to turn as much as possible of these increased earnings into War Bonds—War Bonds for Christmas . . . and War Bonds the whole year 'round!

**GIVE THE PRESENT WITH A FUTURE—WAR BONDS!**

**This space contributed to Victory by RADIO RETAILING TODAY**

*This advertisement prepared under the auspices of the United States Treasury Department and the War Advertising Council*



Auto radios receive attention in this section of Copp's Radio Labs.

### **How one service organization handles large volume of business**

Line 'em up, and use an expert for each type of set, are the rules for turning out radio service jobs at Copp Radio Laboratories, Dayton, Ohio.

Here, production line methods keep the sets moving. Eight servicemen, each a specialist for certain makes and models, repair a maximum number of receivers with a minimum of equipment. Complete knowledge of typical problems in all types of sets—home, auto and portable—is the answer to speed and efficiency.

Mr. M. A. De Voe, in charge of the service department of Copp Radio Labs., points out that there are more servicemen on the job than one suspects. While many younger men are in the armed services completing their technical knowledge, men who have spent the past 15 or 20 years in radio maintenance work have a thorough and practical knowledge and

## **Production Line Service**

Home-set troubles quickly diagnosed by experts on mass production basis.



are still on the job as they are beyond draft age. With many old sets coming out of attics for additional duty these days, knowledge and experience with early circuits save repair time and costs.

### **Efficiency Setup**

Notice in the two photos (at left) of this shop, the use of separate pieces of test equipment rather than a panel type of service bench. Here, the units are free to be moved around from one bench to another. Where a large number of sets are under repair at all times, it is easier to move the equipment than the chassis, particularly when its a Radiola 80 power pack or similar "heavy weights."

Copp Radio Labs. spend 90% of time on service. They do a large volume of auto radio business—working through auto dealers in and around Dayton.

CONTINENTAL RADIO & TELEVISION CORPORATION

*announces a change in name to*

*Admiral  
Corporation*

As a preliminary to extensive post-war plans now under consideration, the simplification of our corporation name appears as a logical step. In radio and magazine advertising the Admiral trade-mark is today being widely exploited. It is the name Admiral, we hope Mr. and Mrs. America will remember when peace will again permit the purchase of a radio for the home.

*Admiral Corporation*

General Offices: 3800 CORTLAND ST., CHICAGO 47, U. S. A.

*Peacetime Makers of "America's Smart Set"*



# SPRAGUE

## A FREE BUY-SELL-EXCHANGE

**WANTED**—Will pay cash for high-grade signal generator. Can also use Supreme #562 audiolizer. Have practically new Delta jig saw to trade if desired. All letters answered. Martin Radio Service, 142 Ralph Ave., Brooklyn, N. Y.

**WANTED**—Phono oscillators regardless of condition, with or without tubes. Describe fully. Name price. Buddy's Radio Service, 620 Main St., Freemansburg, Pa.

**WANTED**—Will pay good cash price for tube tester and set checker. Describe fully. Thomas H. Mann, 26 E. County St., Phoebus, Va.

**WANTED**—Pocket multimeter of any good make in good condition. Have for sale Philco dynamic tester and Triplett vibrator tester #1671, both in good condition. Royce Saxton's Radio Shop, Route 1, Pontiac, Ill.

**WANTED**—Used microphone in good working condition, record recorder, A-C voltage meter, etc. Describe fully and name price. Have parts, magazines, books, stamps, etc., to swap. Joseph J. Mayer, 556 Vineyard St., Bethlehem, Penna.

**WANTED**—Any good 2" or 3" oscilloscope. Name price and describe fully. Have 3 brand new crystal cartridges to fit most pickups. Also have 8" PM speaker. Would like to buy 0-1 ma. meter. Geo. Miller, 520 W. 124th St., New York, 27, N. Y.

**WANTED**—Receiver for S-W telegraph reception—any kind from 3 tubes up. C. J. Nelson, Cheyenne Wells, Colo.

**SWAP OR SELL**—Hallicrafters SX-18 Sky Challenger receiver complete with crystal; Jewell meters, model 54, 0-15 ma. and 0-6 volts D-C; Jewell set tester model 199 less cable and plug, in excellent cond.; Teco T-15 V-O-M, A-C operated. Want voltohmmyst and late model signal generator. Byron Radio Shop, Byron, Ill.

**FOR SALE**—Misc. items such as meters, transformers, tubes, kinalamps, PE cells, etc. also sound picture text books. Write for list. All letters answered. J. J. Cermak, 1928 Grove Ave., Berwyn, Ill.

**WANTED**—Late type tube tester. Will swap or sell Auburn amplifier model XP-15861, de luxe. Walter Kohler, Syosset, L. I., N. Y.

**WILL TRADE**—Will swap Thordarson 60-watt 6L6 parallel push-pull amplifier with tubes, speakers, 500 ohm line transformers, mikes, electric turn table and exponential horns; also individual speakers, field supplies, and one 30-watt amplifier on Howard communications receiver model 490 and 80- or 100-watt transmitter. Reliable Radio Service, 608 Yellowstone, Alliance, Nebr.

**WANTED**—Aerovox L-C checker. Will buy or swap. Have 872-A, 838, 805, TZ-40, and 800 tubes (several of each) for sale or swap. Delaware State Police, Radio Dept., Dover, Del.

**WANTED**—Comb. tube and set tester, preferably Radio City 803 or Simpson 450. Elmer H. Neumann, 2906 E. 25th St., Vancouver, Wash.

**FOR SALE**—Stancor #415 P.A. amplifier with tubes, nearly new. Has 3 input channels; 5 output impedances; peak limiting; 15W/25W, A-F reproduction. Write for full details. Cecil R. Malmgren, 2924 Alabama Ave., St. Louis Park, Minneapolis 16, Minn.

**WANTED FOR CASH**—Rider's manuals vols. 1 to 13. Geo. M. Gum, Fort Slocum, N. Y.

**SALE OR TRADE**—Brand new RCA modernization kit for converting tube testers nos. 156 or 156-A. Check Bantam tubes and 117 volt types. \$10 or will trade for good ohmmeter. Johnson's Radio Service, 1627 Mershon St., Saginaw, Mich.

**WANTED**—Will pay 10c per lb. plus transportation for open and burned out power and audio transformers; R-F, I-F, and osc. coils; R-F, A-F, and filter chokes. How many do you have? Rudy, Roland, Iowa.

**FOR SALE OR TRADE**—2 UX-281; 1 CX-310; 1 CX-112-A; 1 UX-22-A; 1 CX-122-A; 2 CX-301-A; 2 UX-201-A; 1 Myers oblong tube; 1 Silver-Marshall 225 audio; General Radio 565-B power trans.; Thordarson, 2099 choke; 2 Renier var. conds. (adjustable); 2 Western Electric 3-A used photo tubes. Want 3" oscilloscope and Clough-Brengle V-T-V-M. All letters answered. Horace D. Westbrooks, 124 M St., W.S., Thomaston, Ga.

**WANTED**—Pocket AC-DC voltmeter, at least 0-500 volts. Any good make. E. Davies, 2 Potter Place, Weehawken, N. J.

**FOR SALE**—Supreme precision multiwave signal generator, model 180. M. Weinstein, 1711 Morris Ave., Bronx, New York 57, N. Y.

**FOR SALE**—New std. make radio tubes: 20 each of 6A7, 6A8GT, 6F5GT, 6Q7GT, 6SA7GT, 6SK7GT, 6SQ7GT, 6K7GT; and 10 each of 6L6G, 25Z6GT, 6H6GT; and 46. E. A. O'Connell's Radio Shop, Westfield, N. Y.

**WANTED**—Will pay cash for Radio City tube and set tester in usable condition or which can be reconditioned. Other good types considered. John H. Cutko, 1110 E. W. Grand Ave., Springfield, Ill.

**WANTED**—New or used Readrite meters, DC voltmeters, ammeters, and milliammeters. Send details and prices. Robert Freed, 1140 5th Ave., New York 28, N. Y.

**WANTED**—One 15B6 tube. State price. Lyndall J. Hubbell, Jetmore, Kans.

**WANTED**—Any good, late model set analyzer, preferably Supreme. James Hoscic, 1530 Archer Rd., Parkchester, Bronx, New York, N. Y.

**WANTED**—1 A7GT tube, two 1/2-watt neon bulbs, and an 0-35 A, 0-50 V. battery tester. Loyd Rodgers, Route 1, Grapevine, Texas.

**WANTED**—S19R or similar communication receiver. State price and condition. Harold L. Parker, 123-07 103rd Ave., Richmond Hill 19, N. Y.

**FOR SALE**—Battery charger, \$20; 750 V. motor generator and 1/8 h.p. motor, \$10; 20-watt sound projector amplifier and speaker, \$140; also Shure hand mike and misc. radio parts. Write. Central Films, Hastings, Mich.

**URGENTLY NEEDED**—Supreme 504-A tester, Sprague Telohmike, and Supreme vedolyzer. Cash. Eddie, 1724 Central, Middletown, Ohio.

**FOR SALE**—Following tubes, new and used: 80, 1C5G, 1H5G, 5Y3, and many others. Also condensers, resistors, and toggle switches, all new. M. Okin, 915 Bryant Ave., Bronx, New York, N. Y.

**TRANSFORMERS FOR SALE**—All new. Thordarson: 3-T61A96; 3-T6195; 1-T6197; 2-T6123; 3-T65D78; 1-T5289; 1-T6790; 1-T6374; 1-T5749; 2-R100; UTC; 11-R33's; Stancor: 4-A73; 3-A74YP; 1-A72 YP; 1-A74; 1-A4414; Kenyon: 2-KVL; 1-382M; 3-BLL; 1-BPL; 1-Ka55; 1-KR892; 6-KPG; 1-Ku81/KO381; 1-KU82/KO382; 2-KR49M; 1-KR79M; 1-KU14/KA114; 2-KA 15Y; 1-KA34; 1-KR53M; 1-KA32; also one Weston 682 tube tester (no charts). Jack's Radio & Music Shop, 14 Bellingham St., Chelsea 50, Mass.

**FOR SALE**—Multitester, also tube tester. Write for details. Wa Rider's Manuals. R. Robleski, Hasings, Mich.

**FOR SALE**—Super Skyrider SX- and speakers, only slightly used. Will swap the following tube 25Z5; 25Z6, 27; 35Z5; 35L6; 12SK7; 12SQ7 for 12A8GT; 12S, GT; 14QT; 1A7GT; 1H5GT. AI have a Supreme 500 automa analyzer and tube tester; an RC signal generator with two extra sets of batteries; also new RCA capac amplifier and relay; also 0-1 n meters and various other typ Bowman Radio & Neon Co., 9 Mass. St., Lawrence, Kans.

**TUBES FOR SALE**—Brand new: 6L 6G5; 12Z3; 89; 1Q5GT; 1C5G 1A6; 1F6; 15; 48; 81; 85; 31; 39; 6Y5; 1H6G; 2A7; 2A6; 1J6 1E6G; 1E7G; 1B5; 01A; 6Q6G; 1E 20; 22; 33; 39/44; 46; 79; & 4E Supplier's certificate required. AI have compl. set antenna and coils (17 coils) covering 540 kc 30 mc—\$3. Power transformer 1 V. 25 or 60 cy. delivers 250 V. 55 ma., also 2.5V. at 5.5 amps. a 5V. at 2 amps., \$3. I-F transformers at 55c ea. N. J. Cooper, 46 N. Damen Ave., Chicago 25, Ill.

**FOR SALE**—Following tube typ both used and new in factory sealed cartons: Raytheon 6AC5 RCA 1A7G; 80; 33; and 26. A have condensers, toggle switch and phono motors with turn tabl Send oers. M. Thuman, 897 B ant Ave., Bronx, New York, N. Y.

**WILL TRADE** one RCP volt-oh milliammeter 446; RCP ful checker 309P and RCP signal generator #702 all in 1st class condition for a good amateur radio ceiver. What have you? How: M. Miller, 313-44th St., Newp News, Va.

## ASK FOR ATOM by Name

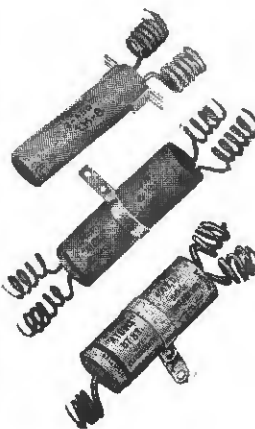

If you appreciate the Trading Post Advertising Service—and hundreds of servicemen have told us that they do—we know we count on you to ask for Sprague Atom midgeet dry electrolytic capacitors by name and to insist on getting them whenever they are available. Sprague Atoms are ordinarily made in numerous single-section as well multi-capacity values—and you can make hard-to-get replacements by strapping individual Atoms together. Atoms are small less costly, and are fully as reliable as big, old-fashioned condensers they replace. Use them universally on all of your jobs. They're more dependable—they speed your work!

# SPRAGUE CONDENSERS

Obviously, Sprague cannot assume responsibility for, or guarantee goods, etc., which might be sold or exchanged through above classified advertisement



# TRADING POST

SERVICE FOR RADIO MEN



**WANTED**—Late model tube tester signal generator—any make but st be good. Cash. Paul W. White, 1617 Barnes St., Kingsport, Tenn.

**WANTED AT ONCE**—Allied's 1N060 section filter condenser; 2N279 inductor coil; and 1N058 400 ohms cord—all from Knight 3-tube radio oscillator kit. C. Goodman, 5 Esplanade Ave., Montreal, Canada.

**WANTED**—Will pay \$1 for instruction booklet on Simpson model tube tester and analyzer. Duhem Motor Picture Mfg. Co., 135 Hayes St., San Francisco, Calif.

**WANTED**—A converter for a 5-tube battery radio using 1 1/2 A. and B. Must operate on 110 V. AC. C. Higbee, Box 125, Anaheim, Calif.

**WANTED**—Late model tube tester pocket-type V-O-M. State price and price. Cecil A. Smith, 7 Wells Ave., Baltimore 19, Md.

**BEST WANTED**—Types 12SA7; 6XK7; 12SQ7; 12A8; 12K7; 12J7; 6X7; 25Z5; 1A7; 1H5; 7A8. Will pay in any quantity for cash. Also if late condenser tester and er's manuals 2-3-8-13. Robert Rowitz, Roda Radio Electric Service, 1308 Castle Hill Ave., Bronx, N. York, N. Y.

**WANTED**—Hickok 188x signal generator. Will pay good price. Debbely, The Yarbrough Company, N. State St., Lyons, Ga.

**WANTED**—One pair of good used headphones—preferably at less than \$5. Vernon Wright, Box 964, Mcfield, Texas.

**WANTED FOR CASH**—Vibroplex de model speed key. State price condition. Saf. Barton E. Brooke vice Co., 754th Tank Bn., A.P. 502, San Francisco, Calif.

**WANTED**—Late model signal generator for 115 V. A-C 60-cycle use. Good condition. Also want Rider's Manuals 10-12-13. Will buy good stock of parts. Edwin Cooper, R. 2, Box 32, Baxter Springs, Kans.

**WANTED**—Small used radios, also small chassis tester, radio service notes, handbooks, circuits, and diagrams. Will pay cash and shipping charges. D. McMullen, 11510 65th St., Edmonton, Alta., Canada.

**FOR SALE**—CB 79B audio oscillator, 88vtvm. Superior utility tester. Burton-Weber R-F oscillator. Mikes: Brush BR25, Electrovoice 605; Shure 9824A. Atlas floor and banquet stands. PM speakers: 2-8", 2-10" (Utah) and one 8" Cinaudagraph. One 6" WD universal speaker, and one 3" 3000 field Utah. Split case for amp. mike, two speakers, and cables. Write for details. O. J. Bolduc, 16 Siegel St., Worcester 3, Mass.

**WILL SWAP OR SELL**—Airline universal 6-volt DC or 110 V. A-C portable sound system with automatic record changer. Uses either 10" or 12" records with one mike input, also one mike and speaker output, 30-watts. Also offer RCA ribbon mike and stand; also one G-E portable radio. Write. J. H. Bell, 4907 Leland St., Dallas 15, Texas.

**OSCILLATOR WANTED**—to produce I-F frequencies from 100 kc to 500 kc. and R-F frequencies to cover std. broadcast or higher. Casn. Louis D. Grady, Jr., Walterboro, S. C.

**WANTED**—Rider's manuals Vols. 4 to 13 for cash—also a signal generator such as Precision E200, or any other good oscillator. State lowest price. J. Sollima, 89-33 238 St., Bellerose, L. I., N. Y.

**FOR SALE**—New Astatic microphone \$1.04 with cable plug, \$14; also used Amperite ribbon mike model RBH, \$8. Frank P. Dane, 3852 Eagle St., San Diego 3, Calif.

**WANTED**—A Scott 20- or 30-tube, or a McMurdo Silver Model VI receiver in good condition. Paul Capito, 637 W. 21 St., Erie, Pa.

**FOR SALE**—Precision signal generator #E200, range 90 kc. to 44 meg., \$65. Also Rider's manual No. 1, \$5. William J. Hartin, 27 Chestnut Ave., Jamaica Plain, Mass.

**WANTED**—RCA-Rider channel type 162-C in good condition. Cash. Pfc. Aaron Hollandmoritz, 313 M. P.E.G. Co., Fort McDowell, Calif.

**FOR SALE**—New Motorola frequency modulator converter. Retail value \$39.95. Will sell reasonable for cash. Jacob Winegrad, 937 W. Huntingdon St., Philadelphia, Pa.

**WILL SWAP**—RCA hi-imp. dynamic mike with 25' cable and floor stand for Meissner or G-E F-M tuner. A. Lampinen, 3443 N. Halstead St., Chicago 13, Ill.

**SELL OR TRADE**—6 to 180 V. power pack, dynamotors, power transformers, condensers, and QST magazines prior to 1941. Want copies of QST from 1941 to date. E. Carter, 814 Craig St., Schenectady, N. Y.

**WILL SWAP**—Rider's manuals vols. 1 to 8 incl. in A-1 cond. on tube checker analyzer and signal generator in good condition, or will pay cash. Vogue Radio & Service, 2725 Boston Blvd., Detroit, Mich.

**WANTED**—Hallicrafters "Sky Buddy," also one 12A7 tube. Cash. Robert Spoon, 16900 Mark Twain, Detroit, Mich.

**WANTED**—Vacuum tube voltmeter or Supreme audolyzer in good condition. Name price and describe fully. Glen Peterson, Glen Miller, Ont., Canada.

**WILL TRADE**—Have following for best offer of cash or photographic eqpt.: One new Leeds & Northrup outer-reading microammeter model #2420-C. Write for details. Pfc. Marvin Lustgarten, ASTP 4431, University of Tennessee, Knoxville, Tenn.

**WANTED**—Rider's manuals vols. 1 to 13 with index. Must be in good condition. Cash. Radio & Electric Service, 2215 No. 14th St., Terre Haute, Ind.

**FOR SALE**—Some new medium price-class D.C. ma. and D.C. volts, meters. What do you need? Wm. Markham, 340 Orange St., New Haven, Conn.

## YOUR OWN AD RUN FREE!

The "Trading Post" is Sprague's way of helping radio servicemen obtain the parts and equipment they need, or dispose of the things they do not need during this period of wartime shortages. Here, then, are a few hints which may help you benefit from it:

Answer interesting ads while they are "fresh." Don't wait until the magazine is several weeks old. Write direct to the advertiser.

Study the "For Sale" ads first to see if what you need is listed before sending in your "Wanted to Buy" ad. The Trading Post appears regularly in Radio Retailing Today, Radio Service-Dealer, Radiocraft, Radio News, and Service.

Please do not specify the magazine in which you would like your ad to appear. We'll do our best to get it in one of the leading publications, but it only complicates matters when a certain publication is specified.

Please don't ask us to run an ad in which you ask more than the normal price for parts or a piece of equipment.

Don't offer to accept C. O. D. telegraphic or telephone replies to your ad. Some individual Trading Post classified advertisements have pulled as many as four and five hundred answers!

Answer ALL inquiries to your advertisement promptly. This is only common courtesy.

When sending your ad to Sprague, please address it to the department number shown below.

Obviously, ads featuring equipment "For Sale or Trade" generally bring better results than those wanting to buy hard-to-get equipment. Preference will thus be given to ads offering equipment for sale.

Write your ad carefully, clearly, and keep it short. Many ads received are unintelligible or hard to decipher—and this causes unnecessary trouble.

"Emergency Ads" will receive first attention and Sprague, of course, reserves the right to eliminate any ads which do not seem to fit in with this special wartime advertising service.

**SPRAGUE PRODUCTS COMPANY**  
Dept. RRT-312  
NORTH ADAMS, MASS.

## HOW TO SUBSTITUTE CONDENSERS Accurately!

Write today for your free copy of the unique "VICTORY LINE" Folder, listing the Sprague Atom Electrics and Sprague TC Tubulars now being produced under wartime restrictions for civilian service use, this folder contains information that will be mighty helpful to you in making these 18 "Victory Line" Condensers do the work of 473 Condensers normally included in our catalog. The Folder tells you, for instance, how to replace 600-volt Capacitors with 450-volt types; how to use dry wet electrolytic jobs; and much more. Post card mailed today will bring you copy.



**WRITE FOR YOUR COPY!**

# KOOLOHM RESISTORS



## Teletalk BANISHES THE GHOST OF EXCESS COSTS

Ghosts of man-hours lost make an eerie procession through many a busy office and factory, stalking busy executives, loading them down with excess costs.

They are spectres of the things they might have done . . . if they had the time . . . time that Teletalk Amplified Intercommunication Systems can give.

These war-harried executives are waiting for you to tell them of Teletalk's modern miracle of speedy intercommunication . . . waiting for you to show them how with Teletalk every key individual in an organization

is in touch with every other . . . instantly . . . at the flick of a key. Sales figures, production data, orders . . . all can be checked without jumping up from a desk . . . without waste of time and steps.

If you are not now selling Teletalk, you should get in touch with us at once. Teletalk is easy to install . . . operates from the light circuit . . . is available in systems to fit both the large and small office.

Write us today. Make Teletalk a profitable addition to your business.

### BUY MORE WAR BONDS

Licensed under U. S. Patents of Western Electric Company, Incorporated, and American Telephone and Telegraph Company



WEBSTER ELECTRIC COMPANY, Racine, Wis., U.S.A. • Established 1909 • Export Dept.: 13 E. 40th St., New York (18), N. Y. • Cable Address: "ARLAB" New York City

# WEBSTER ELECTRIC

"Where Quality is a Responsibility and Fair Dealing an Obligation"

## RADIO *Retailing* TODAY

DECEMBER, 1943

Page	
15	EDITORIALS
16	RADIOS & AIRPLANE MODELS
18	INVENTORY POINTERS
20	RADIO MEN IN ACTION
22	SINGING COWBOYS
24	JOBBERS IN WARTIME
26	BREAD & BUTTER IN PLATTERS
28	RECORDS RESERVED
30	PUSH THE RECORD LIBRARY
34	APPLIANCES TIDE OVER
36	MAGNETIC COOKING
38	RADIOS GO CAMPING
40	REFRIGERATOR SALES TIPS
42	REFRIGERATOR IDEA MEN
44	POSTWAR RETAILING
46	SERVICE IN WISCONSIN
48b	RECORDS TO THE RESCUE
48d	PRODUCTION LINE SERVICE
50	SERVICE & MERCHANDISING
52	NEW CIRCUIT CHANGES
54	WHAT'S NEW
56	BOOKLETS IN REVIEW
58	WASHINGTON WAVELENGTH
60	LETTERS TO THE EDITOR

Ewing Galloway photo—p. 19.

RADIO Retailing TODAY, December, 1943 Vol. 28, No. 12, 25c a copy. Published monthly by Caldwell-Clements, Inc., 48 Lexington Ave., New York 17, N.Y. M. Clements, president; Orestes H. Caldwell, treasurer. Subscription rates United States and Latin American countries, \$1.00 for one year, \$1.50 for two years, \$2.00 for three years. Canada \$1.50 for one year, \$2.00 for two years, \$3.00 for three years. All other countries \$2.00 for one year, \$3.00 for two years, \$4.00 for three years. Printed in U.S.A. Re-entered as second class matter August 28, 1942, at the Post Office at New York, N. Y., under the act of March 3, 1879. Member of Audit Bureau of Circulation. Copyright by Caldwell-Clements, Inc., 1943

**ORESTES H. CALDWELL**  
Editor

**M. CLEMENTS**  
Publisher

H. L. M. Capron, Merchandising Editor  
William E. Maulic, Technical Editor  
Helen Thurman, Associate Editor  
John L. Stoutenburgh, Associate Editor  
Charles F. Dreyer, Art Director  
E. T. Bennett

M. H. Newton  
Lee Robinson  
B. V. Spinetta  
N. McAllister

John A. Sambo  
O. H. Sutt  
W. W. Swigg  
J. E. Cochr.

R. Y. Fitzpatrick, Chicago, 201 N. Wells St.  
Telephone RANdolph 9225

Editorial and Executive Offices  
Telephone PLaza 3-1340  
480 Lexington Avenue  
NEW YORK



*"In recognition of Service beyond the call of duty . . ."*

In this grim business of war, the men in uniform take the risks; they deserve the decorations.

We tube manufacturers don't expect medals. When, however, credit does come our way . . . and when it comes from such a man as Paul V. Galvin, President of RMA . . . it makes us mighty proud and happy.

"Let me take a moment for special mention of the tube engineers. Too often they are not fully recognized. We see fine accomplishments in apparatus, but we fail to appreciate the important work that has been done be-

hind the scenes by the tube engineer. Hats off to you—your accomplishment has been most extraordinary. But you, also, you cannot as yet rest upon your oars. The job is not finished, and new and additional accomplishments are required before we are finished with this war." \*

Hytron engineers realize fully that "the job is not finished", and they continue to strive for "new and additional accomplishments" needed to win the war. Their aim is to develop better tubes to make possible better fighting equipment—let the decorations fall where they may.

\* Excerpt from address of Paul V. Galvin, president of the Radio Manufacturers Association at the Institute of Radio Engineers' Rochester Fall Meeting, November 9, 1943.



OLDEST EXCLUSIVE MANUFACTURER OF RADIO RECEIVING TUBES

**HYTRON**  
CORPORATION ELECTRONIC AND RADIO TUBES

SALEM AND NEWBURYPORT, MASS.



BUY  
ANOTHER  
WAR BOND

# THE RADIO HALL OF FAME

*A New Program Conferring,  
Broadcasting's Weekly Accolade  
Upon the Great Entertainment  
Talent of Our Time*



*Sponsored by*

**The Philco Radio  
and Television Company**

*Over the Blue Network  
Sundays 6:00 to 7:00 P. M. EWT*

**O**N Sunday, December 5, at the Ritz Theater in New York City, THE RADIO HALL OF FAME had its premiere—a premiere that was heard clear across America.

That was the debut of a new program—but, even more, it was the debut of a great new idea in broadcasting. In cooperation with the Editors of VARIETY, one of the leading publications of the show-world, the sponsor and producers of THE RADIO HALL OF FAME pay weekly tribute to the top radio, stage and screen talent of our time.

Each week, the program presents (and thus brings additional recognition to) the personalities in entertainment—men and women who have earned a place on the program because they have become “hits” in the world of entertainment.

One week, it may be a dramatic actress and a comedian; the next, a distinguished musician or a war-front reporter. Again, it might be the week's top name band or the current “spotlight” singer. The opening program, for

example, presented the radio version of “Winged Victory Broadway's new “smash-hit”—and Bob Hope and Hildgarde and Jimmy Durante. The music for this great show is provided by a great showman—Paul Whiteman and his orchestra and the commentator is the celebrated Deems Taylor.

## **Philco**

*For Pleasure in Peace—For Victory in War*

100% of Philco's manufacturing facilities are now devoted to war work—making instruments upon which our armed forces in every theater of war depend. But even in wartime, Philco recognizes the need for entertainment—and by sponsoring THE RADIO HALL OF FAME seeks to keep America's radios, of whatever make, the greatest possible source of pleasure and entertainment. THE RADIO HALL OF FAME has universal appeal—listen!

*The Blue Network*

RADIO Retailing TODAY • December, 1941

THIS IS

# Today's Radio!



Communications are the lifeblood of today's war tempo . . . whether they're signaling "bombs away!" over the inter-com system of a bomber five miles above a vital target . . . or aiding a sleek submarine as it stalks its unsuspecting prey through the silence of the deep. That is radio today. When peace comes, with it will come greater FADA skills developed by wartime lessons . . . devoted to the production of FADA radios with hitherto undreamed-of tonal faithfulness, performance and durability.

PLACE YOUR FAITH IN THE

## FADA Radio

OF THE FUTURE

*Famous Since Broadcasting Began!*

**FADA RADIO AND ELECTRIC COMPANY, INC., LONG ISLAND CITY, N. Y.**



## Remember when you went Christmas shopping:

**Y**OU found everything you could carry away—from a tricycle for Junior to a 15-pound turkey.

Maybe we all took such good things too much for granted. And that applies to the abundance of stock that your jobber immediately supplied you when he could.

It's more than just restrictions that your jobber is coping with now. Chances are, he is just as deep in war work as any manufacturer.

*For example, a great shipyard was behind the 8-ball. Parts were needed to repair the control panel of a new ship just before her trial run. After contacting every marine supplier in vain, the shipyard had the good judgment to call on a local radio jobber who had what was needed in stock.\**

Sylvania is proud of the radio jobber's war record. What he does is usually an emergency job—often secret—often done at the expense of good will with you and other radio retailers.

Though he is putting first things first in the matter of supplying war plants and the armed services, your radio jobber is playing fair with you, to the best of his ability, with what he can get from manufacturers.

When the war is won, the radio jobber will be more important than ever to manufacturer and retailer in supplying the great radio, electronic and television markets that are bound to come.

*\*An actual case from our files, details of which must now be withheld for reasons of military security.*

..... **SYLVANIA**  
**ELECTRIC PRODUCTS INC.**  
 Emporium, Pa.

**RADIO TUBES, CATHODE RAY TUBES, INCANDESCENT LAMPS, FLUORESCENT LAMPS, FIXTURES AND ACCESSORIES, ELECTRONIC DEVICES**



**W**E bring you the Greetings of the Season—with the wish that Victory and Peace may soon find our families and friends re-united in the simple pleasures of the home—in the enjoyment of our books, our pictures, our radios and other fireside treasures.

*The entire personnel of*  
**ZENITH RADIO CORPORATION • CHICAGO**



*Better than Cash*

**U. S. WAR SAVINGS STAMPS AND BONDS**

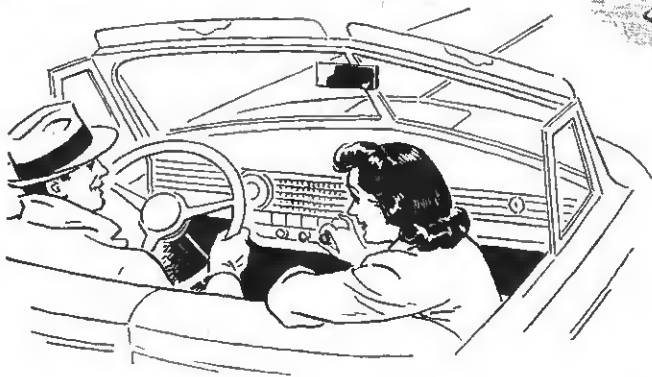

## From "Music on the Road" ...a Clearer Voice for War

Few entertainment mediums operate under such unfavorable conditions as the automobile radio. It sings its arias on a "stage" that bounces and jolts. It cracks its jokes while trolley-wire "lightning" snipes at its sensitive nervous system. It reads its news reports under the savage attack of high-tension current from the automobile ignition system. Even temperature and humidity get in their licks. Talk about a "dog's life"! Rover, move over.

For years, Delco Radio technicians have applied themselves to overcoming the many problems of vehicular radio. One by one, vibration—electrical interference—humidity and tem-

perature—and other trouble-makers fell before their relentless quest. Automobile radio lost its stutters and gained a calm, clear voice.

But more than better entertainment came with this conquest. In their eternal search for "a better way," Delco technicians were finding the answers—*years in advance*—to similar problems of war-vehicle radio communication. When war struck, they already had a sound working knowledge of the chief deterrents to practical radio communication in bombers, tanks, tank destroy-

ers and other mobile units. The quest for better entertainment had yielded an invaluable by-product—a clearer voice for war.

**Delco Radio**  
DIVISION OF  
**GENERAL MOTORS**

★ ★ **BACK OUR BOYS . . . BY BUYING BONDS** ★ ★ ★ ★



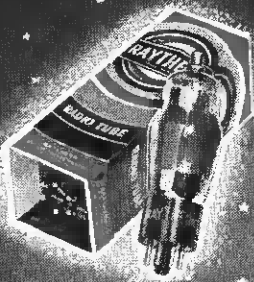

# RAYTHEON DISTRIBUTION

**B**efore the war, tubes made by RAYTHEON were used by the majority of important receiver manufacturers . . . because RAYTHEON tube developments kept pace with the latest engineering thinking . . . aiding RAYTHEON set customers in keeping at the top of the art in receiver designs.

During the war, there has been a 1000% increase in RAYTHEON technical achievements in protecting the vast requirements of our Army and Navy.

After the war, the nationwide RAYTHEON distributor and dealer organization will be better fortified in keeping the nation's receivers and electronic devices in operation.

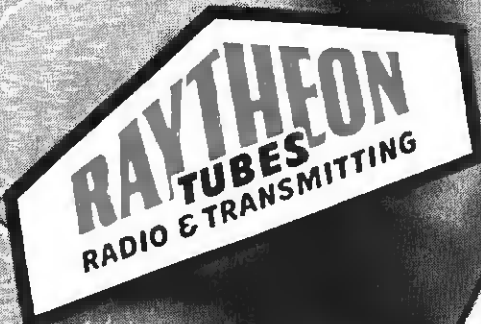

FOUR "E" AWARDS  
Each Division of Raytheon has been awarded the Army and Navy "E"

**RAYTHEON PRODUCTION CORPORATION**  
NEWTON, MASS., LOS ANGELES, NEW YORK, CHICAGO, ATLANTA

DEVOTED TO RESEARCH AND THE MANUFACTURE OF TUBES FOR THE NEW ERA OF ELECTRONICS

RAYMOND  
**LOEWY** is designing

**Emerson**



**Raymond Loewy**, America's outstanding designer of everything from "lipsticks to locomotives, from toothbrushes to military equipment"... is now creating new styles and new features for Emerson Radio-Electronics of the future, **EXCLUSIVELY** for Emerson in the radio industry.

Among the awards and honors conferred upon Mr. Loewy are: 1938 Annual American Design Award (the first year this award was given); Honorary Royal Designer to Industry, Royal Society of Arts, London; Fellow, Royal Society of Arts, London, 1942; Officer Legion d'Honneur, France; Gold Medal for Transportation, Paris International Exposition, 1937; two Grand Awards in Electrical Association Store Competition; 5th Annual Plastics Competition, 1940; All-America Packaging Competition, 1938, 1939 and 1941. Loewy is listed in WHO'S WHO IN AMERICA.

### **AGAIN FIRST IN STYLE, PERFORMANCE AND VALUE**

While every facility is being devoted exclusively to production for war, Emerson's staff of planners is preparing for reconversion, for the rapid reemployment of returning soldiers and sailors.

Included in Emerson's postwar plans are better Style, Performance and Value than ever before.

Raymond Loewy's association and work with Emerson is but one of a long list of advantages which will characterize and enhance the value of Emerson's distributor and dealer franchises.

**EMERSON RADIO AND PHONOGRAPH CORPORATION • NEW YORK 11, N. Y.**

# Radio-Electronics

for the World of Tomorrow!



## FOR YOUR POSTWAR PLANNING

To be issued shortly by Emerson... an illuminating book on "Small Radio... Yesterday and in the World of Tomorrow."

Approximately 100 pages describing and illustrating past experience, wartime achievements and practical suggestions for radio production and merchandising in the future.

Here is an interesting and constructive message which every radio distributor, dealer and salesman will want to read and consider.

"Small Radio... Yesterday and in the World of Tomorrow" is Emerson's forecast of and guide to the great radio-electronics opportunities which lie ahead.

**RESERVE YOUR FREE COPY OF THIS BOOK... SEND COUPON NOW!**

Because of limited edition, copies will be mailed in the order that requests are received.

EMERSON RADIO AND PHONOGRAPH CORPORATION, 111 Eighth Ave., New York 11, N.Y.

Please send me a copy of "Small Radio... Yesterday and in the World of Tomorrow."

Individual \_\_\_\_\_

Firm \_\_\_\_\_

Street \_\_\_\_\_

City \_\_\_\_\_

# "This just isn't my year!"



*"I've never been in such bad shape!*

*"Around this time of year I usually have a bag full of new radio sets for my friends all over the country. This year I have only hope and a promise.*

*"The hope that next year will see the collapse of the Axis . . .*

*"And the promise that Stromberg-Carlson will bring you these three things when victory does arrive:*

**"ONE:** Soon after this war is won you will have a fine line of Stromberg-Carlson radios to sell . . . a line that will win customers and retain their goodwill . . . a line that will offer value and fine performance in a range of prices.

**"TWO:** The Stromberg-Carlson name in radio will be even more widely and more favorably known than ever before.

**"THREE:** The Stromberg-Carlson policy of distribution will permit every authorized dealer to have a real opportunity for profit on the Stromberg-Carlson line.

*"Even if the war is cramping my style, I want to wish you a Merry Christmas and a Happy New Year . . .*

*and remind you that  
"There's nothing finer than a  
Stromberg-Carlson!" "*



## STROMBERG-CARLSON

ROCHESTER 3 • NEW YORK

O. H. CALDWELL, EDITOR  
480 LEXINGTON AVE.,

# RADIO *Retailing* TODAY

Including Radio and Television Retailing

M. CLEMENTS, PUBLISHER  
NEW YORK 17, N. Y.

**SURVEYING SOME OF THE SURVEYS**—Why do some surveys on prospective post-war sales show radio-set figures somewhat lower than most of us believe they will be?

The reasonable explanation seems to be that most people take radio for granted. When we consider that there are more radios in use in this country than tooth-brushes; more radios than telephones, and more radio homes than electrified homes, a questionnaire asking what appliances a person will buy after the war, is obviously going to contain a preponderance of the things the person doesn't own now.

#### **They'll Buy the Sets**

Most homes in the United States currently own at least one presently-operating radio receiver. In normal times, buying a couple of radios now and then was an ordinary course for householders to pursue. Asking them if they're going to buy radios after the war is something like asking them if they're going to buy food after the war. They certainly are going to buy, and that's all there is to it—so many will not bother to mention either the future food or radio-set situation.

Rather, many people will fill in the questionnaire with things they have never owned before. They will take for granted the devices now serving them.

**COVER**—No tube shortage at Bricker Radio, Mansfield, Ohio. See page 50.



## **Retailers Must Grow with the Job**

Speaking before a group of retail merchants in New York, Lewis H. Avery, who heads up the present "radio-for-retailers" campaign of the National Association of Broadcasters, spot-lighted a number of problems confronting present-day merchandisers.

Stating that the first concern of every businessman is "survival", no matter how seemingly strong his present position is, Mr. Avery listed a number of other aims, as follows:

*Holding the kind of customers you want, getting your share of the available business, strengthening your competitive position, keeping that improved profit ratio improving, maintaining your standing in the community, and preparing for a future which may be vastly different.*

The "meat" in the foregoing statements is not "rationed", but is freely distributed to radio-appliance dealers and electronic maintenance men, who may well use the thoughts to nourish their own business viewpoints.

## **The Future for Appliance Selling**

When the war is over, the pent-up buying rush may cause many retailers to inquire about cooling systems for their cash registers.

Instead of salesmen ringing housewives' doorbells the latter may be banging at the dealer front doors all over the country.

Amusingly optimistic? Perhaps. But, from all indications, home appliances will at the beginning be *bought* by the customer rather than be *sold* by the salesman.

That countless thousands of people will demand appliances *they never owned before*—that they will have money to pay for them—and that our manufacturers will be in a position to fulfill this demand, is the composite picture being painted for the retailer.

## **Sales to Skyrocket**

For the *radio* retailer this "masterpiece" is particularly well-lighted. RADIO RETAILING TODAY finds that *most* of the radio dealers we talk to, all over the country, who were *not* in the general appliance business before, have definitely decided to take on refrigerators, laundry equipment, ranges, vacuum cleaners, as well as smaller appliances as soon as they are able to do so.

Radio dealers, who were in the general appliance business before the war, are making plans to be more active than ever when the time comes.

That radio sales will go "stratosphere" toward new heights when production is resumed, is a foregone conclusion. That miscellaneous electrical appliance sales will skyrocket is equally certain.

And, that radio retailers will, for the most part, participate in both these businesses is a pleasant picture for them to contemplate.

## **To Radios, Refrigerators and Appliances This Dealer Adds a Flyer in Airplane Models—and Makes Good!**

• Twenty-three years ago Ellsworth Snyder was repairing radios in Carlisle, Ohio, back when Atwater Kents were new on the market. Next he sold radios, and later he became service manager for the Dayton Zenith office in charge of 22 counties. During the next two years he got the distributor picture, while working for Ohio jobbers. And in 1931 he came to Springfield to operate his own store, selling Crosley refrigerators, Westinghouse ranges, washers, ironers and several well known radio lines. Since that time he has enlarged his store and is now located at 325 W. Main St. in Springfield.

Owner Snyder is a combination of technician, salesman and executive planner—all rolled into one! However, current conditions not being conducive to radio and appliance sales, and with servicing limited by parts and tube shortage, he found he had to turn to some additional and

yet allied line that could be sold to his already large number of homeowner prospects and customers.

### **Local Club Activities**

About five years ago, Mr. Snyder had taken the local airplane-model club under his guiding wing. With no room available elsewhere, this group of 15 to 17 year old boys found a meeting place in the basement playroom of the Snyder home, and Mr. Snyder at that time financed their attendance and participation in the weekly state contests. So he didn't have to look very far for a new line. The Snyder Radio and Appliance store became the sales headquarters for model airplanes selling from 10 cents right on up to the \$15 gas jobs. And that was the beginning.

Since that time Mr. Snyder has organized airplane-model clubs within

the Boy Scout organization, which he serves both as a member of the board in Springfield, and as one of the state directors of airplane-models clubs in the district. In his spare time he also helps the Girl Scouts with their plane-building. Result: He has done about \$5000 per year in the plane model business ever since its installation.

What about that customer list which he developed when radios and appliances were to be had? The answer is that not only the 15-year-olds were interested in plane models, but their fathers and grandfathers looked into it, as well. Many a radio, refrigerator or appliance at the Snyder store was seen, appreciated and bought by customers who came in to talk about planes. With no more radios and few appliances on hand for sale, Snyder's customer list, so painstakingly built in the past, will be good for future use. He is keep-

# **RADIOMAN ON THE**

Dealer Snyder knows servicing from the ground up . . . working 14 hours a day he turned out 450 repair jobs in one month, singlehanded.





Airplane models move in to catch and keep the interest of former radio and appliance customers who will buy again when these goods are available.

## "FLYING" TRAPEZE!

ing in touch with these same people now, through their children's interests!

### Wartime Servicing

Dealer Snyder still carries on repair work on radios and appliances, despite the shortages in parts, tubes and manpower. In February 1941 he

invested \$3000 in tubes and condensers. Some people thought him overstocked, but by the end of the year he had everything he needed to stay in business. At present, however, 162 sets are waiting repair because of missing tubes. Nevertheless, he gets out about 15 jobs a day, and in the month of August turned out 450 re-

paired sets all by himself, working 14 hours a day. Finds tubes have to be searched for, and travels whenever he can locate needed replacements.

This dealer believes in concentrating his efforts on sales and service of radio home sets and large and small appliances for the home. Does no

*(Continued on page 64)*

Pictured when they were members of Snyder's airplane model club, all these 5 young men are now in some branch of the armed forces' air corps. When they return they'll probably be prospects for radios and refrigerators, too. (Mr. Snyder is 3rd from left.)

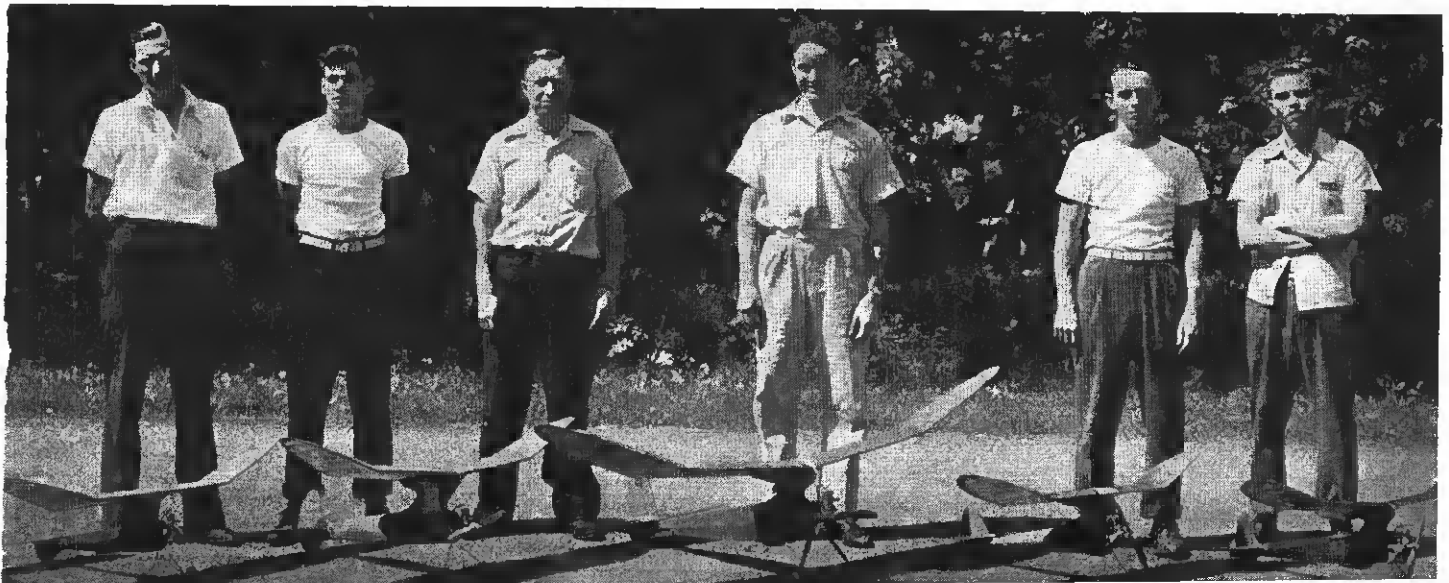

# Short-



marked with its "selling price," and has no other identification in your books. As each shipment is received, the "selling price" is indicated on the invoice, and calculated in total, the same as the cost.

Both "cost" and "selling" prices are indicated on the books, and totaled with all other merchandise, by departments, or merchandise classification.

The difference between "cost" and "selling" is calculated as a percentage of "selling price" and is called "margin" or "mark-up." If any change in selling price is made, a "mark-up" or "mark-down" form is used. The price on each individual piece of merchandise is then changed, and the total change entered on the books, and the margin recalculated.

Sales are entered each day, from

• The whole world prays for "Peace on Earth, Good Will to Men," as the war goes on and leaves its effect on all of us—on our way of life, on our business, and on our loved ones.

But life and business go on. Soon we must account to Uncle Sam for our earnings during the past year, and the profits thereon. In such an accounting the inventory is an important factor. It must be complete and accurate. Bear in mind that this year-end accounting is not for you alone, but is necessary for your government for purposes of determining your taxes.

Your inventory must be valued at "cost." Cost should be "actual cost," or "current cost" (cost as marked), whichever is lower.

## "Merchandise Register"

Many small stores keep a "merchandise register" in which they enter each item of merchandise received, showing cost from their invoices.

Then, by recording the selling price, from the salescheck, against the appropriate entry in the "merchandise register," a perpetual inventory at cost is available.

This also gives "cost of merchandise sold" day-by-day, weekly, or monthly, which must be determined before you can calculate your gross profit.

If you have a merchandise register, when you take inventory you must record full identifying information, other than price, to avoid confusion in checking against the register.

## "Retail" Method

Most large stores use the "retail method." This is a method of averages and has many advantages. The individual piece of merchandise is

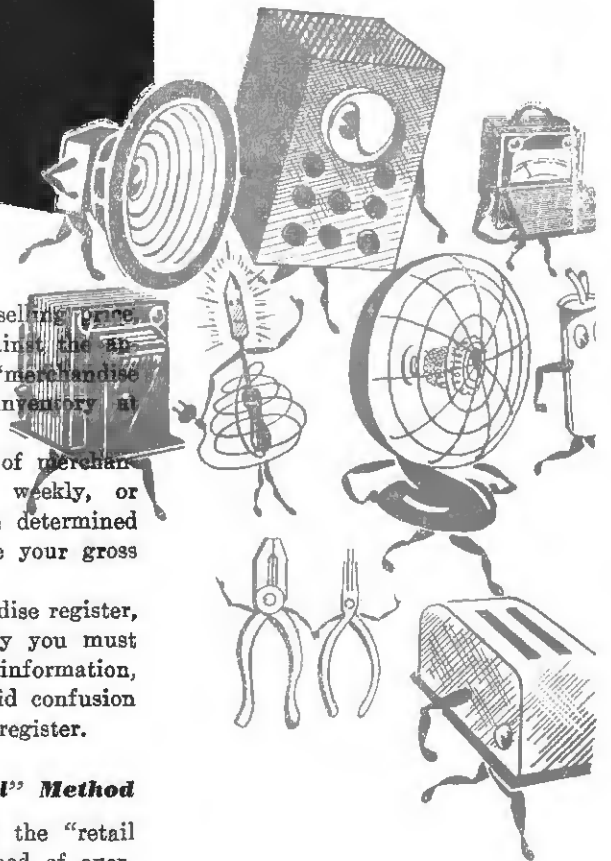



# Cuts in Stock-Taking

**Some Pointers on Your Inventory—More Important Now Than Ever, to Know Where You Stand . . .**

the sales checks, in totals by department or merchandise classification.

"Selling" price is also reduced to "cost" by the amount of the current "margin."

In this way, although each individual piece of merchandise has lost its identity on the books, the "average cost" of any and all merchandise is known.

Inventory then is taken at selling price, which is reduced to cost by departments or merchandise classification by current "margin."

This method has many very marked advantages, but most small stores do not like some of its requirements, such as marking selling price on each item, or having to record every change in selling price.

If you do not use the retail inventory method, or maintain a mer-

chandise register, taking inventory will be a longer and harder job. But it's got to be done, so let's get started.

## **Be Accurate!**

Two people working together, one person counting and calling, and the other recording will work faster, and more accurately than the same people working individually. In taking inventory, provision must be made to check both its completeness and its accuracy.

## **Marking**

Each shelf, fixture should be identified and marked with a letter or number.

If your merchandise is marked, the price tag should be checked (V) as it is counted.

If not marked, some indication of its having been counted should be shown, such as a colored tag, a small sticker, or some other mark of having been counted.

## **Counting and Recording**

Inventory should be taken systematically. On your shelf fixtures, count *every* item on each shelf in a section before going on to another shelf. Record the merchandise of each shelf section on a separate inventory sheet, plainly marked with identification of the fixture. In this way it will be possible to check back your count if any question arises, as it frequently does.

In recording the inventory extreme care should be taken, for it is much easier to *prevent* errors than to run  
(Continued on page 66)

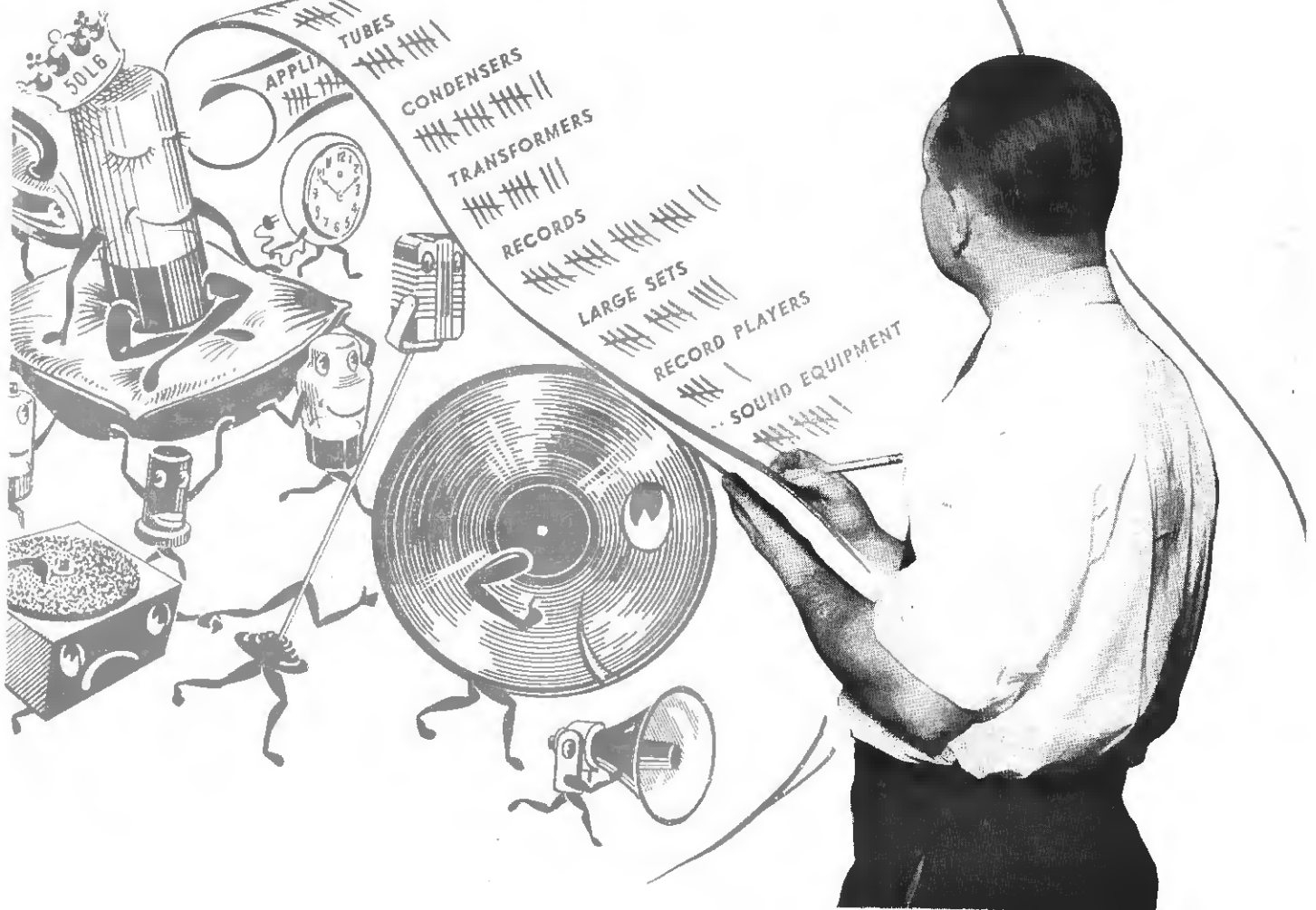

# RADIO MEN IN ACTION

**Dealers Beat the Shortages—Make Money Despite Limitations**

**MOBILE, Ala.**—Proprietor Greenwald of Greenwald's, leading radio repair shop of Mobile, specializes in radios, but he will fix most anything. When a traveling writer for *Radio Retailing Today* arrived on the scene with the speed gun to his camera out of gear, Mr. Greenwald fixed that too. He makes a charge for testing radios. Says this is necessary on account of the time, overflow of work, shortage of help, high labor costs, etc. A sign in his shop explains why this is recently.

**CHESTER, Pa.**—Goodman Radio Service, at 5th and Penn Sts., is making up for wartime shortages by specializing in the installation and rentals of sound systems. In addition the firm is concentrating on the rental of 16-mm. sound movie projectors.

**RIPON, Wis.**—Clarence Brown, who operates an appliance and piano store in this city of 5,000, works in a defense plant during the day and comes to his store nights and on Saturdays and holidays and handles his appliance repair work in this manner. Folks know this and bring their radios in at hours when Brown is at his store. Brown has been in business many years in this small city and has a good location on the town "square."

**WASHINGTON, D. C.**—Radio servicing and record merchandising are the two chief supplemental activities being employed by Sun Radio Co., 938 F St., N.W., according to Harold F. Sugar, manager. "We find these now the brightest spots in our business picture," Mr. Sugar stated. This concern, one of the leading ones in its field in this territory, bought heavily when it became apparent that radio production would be halted, and because of this it was in a position to continue radio selling until quite recently.

**WILDWOOD, N. J.**—Elmer Bishop, radio service firm at 2805 Pacific Avenue, is capitalizing on the return to popularity of bicycle-riding by augmenting its radio and electrical repair services to include the repairing of bicycles. In addition, the Bishop store is emphasizing public address work to make up for restricted activity in the radio line.

**BATON ROUGE, La.**—Speaking of after-war planning, J. F. Burnett, proprietor of Capitol Radio Co., of this city, will build after victory on his present location, which he owns. He has made radio service an exclusive business during the war, but he proposes to sell refrigerators, radios and other appliances in his new store.

**DENVER, Colo.**—Fred Schmid Electrical Appliance Co. concentrates on repairs and has more work than two men can handle. Since Schmid formerly concentrated on sales work, he is now attending night school and learning radio repair work from the bottom up. He has several console and table models left and a few combinations. Schmid has added no new lines to compensate for the loss of new radio sales, which used to average pretty close to \$10,000 per year. Advertises constantly for used radios which are rebuilt and sold, with very good results. Repair work averages \$25 to \$30 per day.

Fred Mazulla of the Mile-High Radio Company has all the business he can handle and does it all himself, where he used to employ 3 radio repair experts. Has cut out public address system and is concentrating on repairs until conditions clear.

Friend's Radio Service is doing considerable repair work, re-working old cabinets, installing newer model radios, cutting new dial and control openings and modernizing old cabinets. Is doing considerable experimentation on substitution of tubes due to the shortage. Renewing old, worn parts and putting them into radios that are being repaired. The demand here tends toward table models which sell as soon as they are put into working order. All repair parts are carefully renewed so that a guarantee can be given on repairs.

**MILWAUKEE, Wis.**—Wm. Sullivan, owner of Sullivan's Radio Shop, 2465 W. Fond du Lac Ave., is kept busy these days doing paging systems work for many local war plants. He comes back to his shop about 4 p.m. every day and handles service in spare time and on Saturdays. His wife takes care of the store while he is out, and accepts radios and appliances for repairs. Besides radios, Sullivan does small appliance repairs and also makes keys.

RADIO Retailing TODAY • December, 1943

## LIKE OLD TIMES!

OPEN TUESDAY NOON 'TIL 9 P. M.

**The LION Store**  
—For Everyday Low Prices—

**Fada Radio And Record COMBINATION**  
Police Domestic And Foreign Bands. \$169.95

**New Attractive 6-Tube Motorola ARMCHAIR RADIO**  
No Aerial Required! \$99.95

**15 Tube Lafayette**—This radio has three bands including Frequency Modulation, Automatic Record Player, 2x Volume! \$389.95

**9 Tube Philco**—This is an automatic record player and radio in a beautiful green cabinet. 4x Volume! \$395.00

**6 Tube Hoopie White**—Automatic record player and radio. 3x Volume! \$189.95

**6 Tube Motorola**—In the low key console style. In a beautiful cabinet. \$89.95

**6 Tube Motorola**—This is a 6-band, low key console with an auto record player. \$109.95

**6 Tube Console**—RCA in a beautiful table model cabinet. \$89.95

**8 Tube Deluxe RCA Combination**—Auto record player and radio. \$495.00

BUY ON THE CLUB PLAN—7% Club Deferral—No cash is advanced monthly.

Current advertising in newspapers placed by the Lion Store, Toledo, Ohio, features some choice models in radios and the "combinations." This store also stresses "club plan" payment offer.

# FROM COAST TO COAST

**ROCHESTER, N. Y.**—Jack's Radio Shop plans sending New Year's cards to all customers on record. The cards read: "My New Year's Resolution—to give you the best service possible in wartime whenever your radio NEEDS IT." This serviceman believes a simple card like this will create good will.

**CHICAGO, Ill.**—With the idea of becoming the community television servicer in the postwar period, L. Owens has opened quarters at 7125 West Grand Ave. The new business is known as the Owens Radio & Television Laboratories. In addition to radio service, the shop repairs all electrical appliances, and also buys and reconditions the latter for resale.

Mack Bros. Radio Shop, 2047 W. Chicago Ave., has been doing a big pre-Christmas business in servicing electric train equipment. According to Howard Mack, there is plenty of activity in radio repairing and in records. The record inventory is about \$2,000, while radio servicing brings in approximately \$800 a month. To accommodate old customers and bring in new ones, this store has a department at which people may pay their gas and electric bills.

The Irving Weitz Radio Store, 2609 W. North Ave., is specializing in instantaneous recordings for customers. The fee, 25 cents, includes a message on both sides of the disc. The service is featured through the use of window banners.

**WATERTOWN, N. Y.**—Mattrau recently received a new supply of portable radio batteries, but he won't sell any unless set is brought into the shop. The customer then has to install the battery himself. This rule is practiced in an endeavor to prevent hoarding.

Radio Hospital places a few schematic diagrams on display, with a placard reading, "How Your Set Looks to Us." Purpose of this is to help customers kill time while waiting for repairman. Reports indicate people enjoy looking over these diagrams.

**WAUPUN, Wis.**—Appliance Service Shop, operated by Walter Dalton, is loaded with radio, washing machine, vacuum cleaner and small appliance work. Dalton has been in business for four years and has come through the war period fairly well, but his stock of tubes is now running low. He has a number of radios he cannot repair because of lack of

**BALTIMORE, Md.**—Hamman's Music Store, 211 No. Liberty St., is supplementing its retail activities with the merchandising of "assembled" electric record players, and has been fortunate thus far in getting a fairly good supply of them, according to F. Burton Hamman, member of the business which is headed by Fred B. Hamman, its founder.

## \$250 Inventory in 1938—Today Over \$20,000



Adams Radio Co., 65 Washington St., Providence, R. I. 43 feet of water in 1938 flood ruined stock, but they've built up again through good location, window-dressing, smart merchandising. Record business booming. With few high-priced radios, new rule is "cash only."

tubes. He charges a minimum of \$1 for a home call, he states, but tries to get customers to bring their radios to his shop. He is operating his business all himself and wants to spend as much time as possible at his bench.

**BINGHAMPTON, N. Y.**—C. E. Alberts, pioneer radio servicer, is sponsoring daily time signals on the radio. Claims expense small, and much more satisfactory than a classified advertisement in a crowded newspaper column.

Music boxes, heretofore looked upon as miniature novelty items, have become an important sales factor in this store, and large number are purchased by the firm to take care of a five-fold jump in sales. These items are offered for \$6.95 up to \$39.95, with the average sale amounting to \$14. According to firm members, music boxes are very popular as gifts for persons in the armed services. The store offers a free packing service for customers who want to send them out as gifts.

(Continued on page 62)

# Cowboys and Gals



Decca posters inspired this colorful eye-catching window at High Point Record Shop in Philadelphia. Decca's "Pistol Packin' Mama" is recorded in two different styles. One at 75c features Bing Crosby and the Andrews Sisters, and is paired with "Victory Polka" (No. 23277). The other retails at 35c and is by Freddie Fisher's orchestra. Flip-over is "Wilberforce, Get Off That Horse!" (No. 4425).

Crosby and the Andrew Sisters (No. 23277) and the other the record made by Freddie Fisher's orchestra (No. 4425). Posters 28" x 15" and 20" x 10" in bright yellow, fire red and western sky blue are available to dealers on application, free. Capitol Records, Inc., has also released a recording of this popular tune: "Pistol Packin' Mama" paired with "Deacon Jones," featuring the Pied Pipers with Paul Weston's Hollywood orchestra (No. 140).

Further success with the western melodies is the tremendous sales potential in "Oklahoma" (Decca Album No. 359). Recording the original cast of this smash hit on New York's Broadway, the music has a lasting quality that will keep its tunes popular for a long time. It's like bringing the show right into your own living room. Dealers are finding it hard to supply the public's demand for this album!

In connection with this feature,

Below is reproduced the album cover of Decca's smash hit recording of the original cast of "Oklahoma" (Album No. 359) which sells at \$5.00. Dealers are having a time keeping this album in stock!



Decca has prepared blowups of the album cover in color, 30" x 37", and another slightly smaller. Counter display in the same colors is actual record album cover size. The colors are yellow, orange and black and create a warm and colorful display.

• "Go West, young man!" was sage advice back in the 1800's. And history will repeat itself very shortly after this war is over. Already plans are being made for jobs in the western sections of the country for returning soldiers and their wives and families.

The cowboy theme is basically a part of our Americana. Our music today already reflects this western surge, in the popularity of music that

people like to hear again and again.

Featuring the singing cowboys on the discs, window displays should be easier than ever to dress. The colorful Old West lends itself to many display ideas and the colorful posters supplied by the recording companies inspire many a traffic-stopping window.

The success of Decca's "Pistol Packin' Mama" was such that the company brought out two different recordings, one, the pressing of Bing

# Ride the Record Range



Gene Autry, Columbia's cowboy singer, has made popular such tunes as "I'm Thinking Tonight of My Blue Eyes" (No. 6648); "I Hang My Head and Cry" (6627) and "Jingle, Jangle, Jingle" (No. 6690).

Decca album booklet in color completes the display features, and may be had by dealers upon request without charge. This booklet can be used to create spot color in your windows.

Other good western numbers by Decca are Roy Rogers' "Think of Me" with flip-over "I've Sold My Sad-

**Roy Rogers—without Trigger!** Before coming east to star in the recent rodeo at Madison Square Garden, Rodgers, exclusive Decca artist, looks over his own collection. His current hit disc is Decca's "Think of Me" backed by "I've Sold My Saddle for an Old Guitar" (No. 6092).



dle for an Old Guitar" (No. 6092), Dick Robertson's "No Letter Today" paired with "I Walk Alone" (No. 4426), and Ernest Tubb singing "Try Me One More Time," reverse side, "That's When It's Comin' Home to You" (No. 6093).

Columbia features Gene Autry as its singing cowboy. His latest, "I'm Thinking Tonight of My Blue Eyes" and "I'll Be True While You're Gone" (Okeh No. 6648) chalks up another hit disc for the singingest, ropingest man to ride a range! Others by Autry that are selling well are "I Hang My Head and Cry" (No. 6627), "Under Fiesta Stars" (No. 6694), "Jingle Jangle Jingle" (No. 6690), "Call For Me and I'll Be There" (No. 6684).

Columbia is bringing out a new album for Gene Autry fans to keep his

**Texas Jim Robertson and his "Round The Campfire" album (Victor Album No. P84) lists at \$2.50. This collection includes well known favorites such as "Red River Valley", "Home On The Range"**

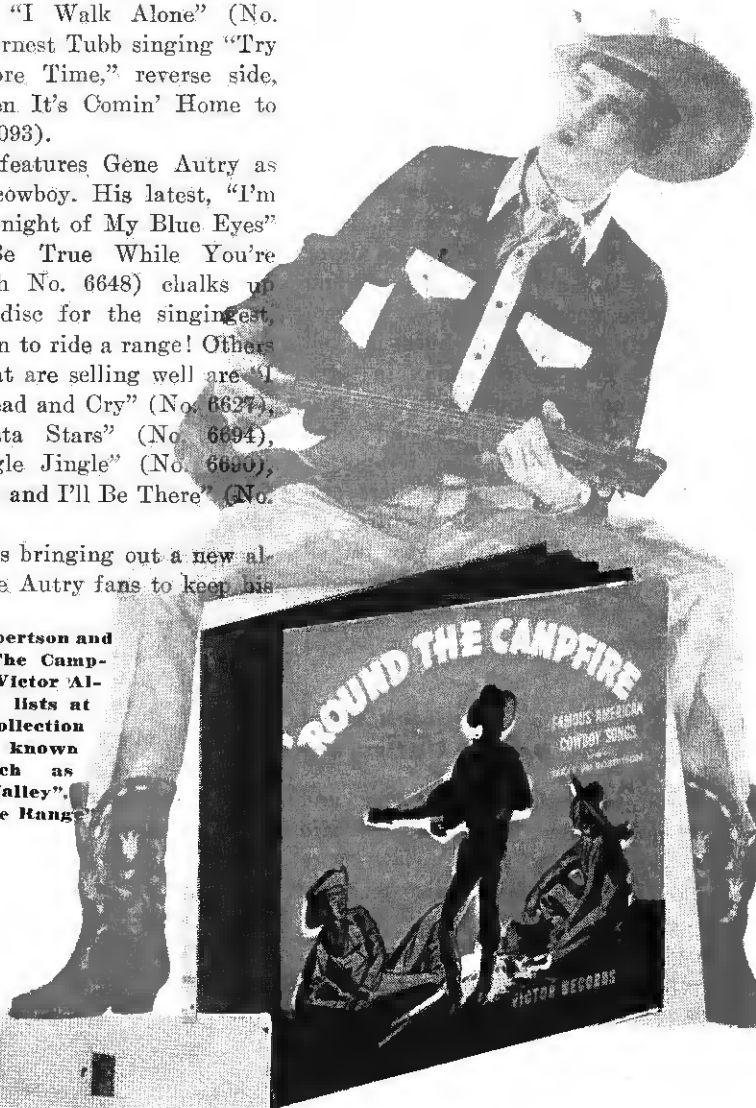

discs in. It should be ready shortly and will retail to the purchaser for 50c. If it is typical of Columbia's usual fine album covers, it ought to make valuable display material for your windows and store interior.

Victor has many offerings in the rolling, loping music that seems to be so typically a part of Americana. They ring the bell with various recordings by Elton Britt of "There's A Star Spangled Banner Waving Somewhere" fame. Montana Slim, the "yodeling cowboy," hails from the Canadian northwest and really is a cowboy. A composer as well as singer, he wrote "I'm Thinking Tonight

(Continued on page 92)

# JOBBER MAN THE

**Keep Merchandise and Parts Rolling to Distributors, Wholesalers and Manufacturers**

• From firmly entrenched beachheads, American distributors keep the supplies rolling to the armed forces, the warplants, and to the civilian fronts.

The essentiality of the wholesaler to the complicated pattern of distribution is being stressed now as never before. His ability to procure and distribute goods efficiently and economically in normal times is well known. That he continues to serve in wartime, with surprising resourcefulness, despite shortages and other complications, is being recognized by the radio-appliance retailers and maintenance men. The manufacturers appreciate this service too. Many of the latter are now definitely committing their organizations to jobber affiliations for the postwar periods.

## **Outlook Good Despite Difficulties**

In interviews with dealers and servicers all over the country, *Radio Retailing Today* finds a few "sore spots" in the wholesaler picture. This is only natural, however, because no vast enterprise like electronic and appliance distribution can be a hundred per cent perfect. But the preponder-

ance of opinion seems to be that the jobbers are doing a bang-up job.

## **Dalis Sets Up Two Separate Divisions**

In New York City, H. L. Dalis, Inc., electronic distributors, did some constructive planning during the early stages of the war. As a result, this supplier is smoothly geared to operate under present conditions.

Like many other distributors, Dalis is doing a big priority business, supplying the armed forces, warplants and war laboratories. Dalis also serves about 2000 dealers in a seventy-mile area around New York. To avoid confusion, this firm set up two separate divisions—one for priority business and one for dealers.

To prevent hoarding, and to give everyone a fair break, Dalis worked out a ration system. Under this plan, every order received is carefully analyzed, and is checked back against previous orders received from the dealer. In this way, the normal requirements of the purchaser are known, and his allotment is based upon these findings. "In this way," an executive advised a representative of *Radio Retailing Today*, "we man-

age to sell a little bit of everything to everyone."

Dalis keeps eleven salesmen—its usual peacetime number—calling on the trade. The original sales force is practically intact.

"We try to get supplies for all," said the Dalis spokesman. "In cases where we cannot supply a required part, we endeavor to suggest substitutes. We give technical advice, also, whenever possible, on the use of such substitute parts." The Dalis organization was founded in 1925.

## **NEDA Chapters Discuss Important Problems**

Chapters of the National Electronic Distributors Assn. have been meeting recently to discuss important distribution problems. The Keystone Chapter met recently at Shoyers Restaurant, Philadelphia. The following were present: Ralph Peffer, Harrisburg, Pa.; Morton Moskowitz, Morris Greene, Eugene Wile, John Stern, Mrs. John Stern, all Philadelphia; Mr. and Mrs. Glenn Zimmerman, Hagerstown, Md.; C. G. Wetzel, Lancaster, Pa.; J. D. Strauss, York, Pa.; Mr. and Mrs. George D. Barbey, Miss Ruth Barbey and Miss

Charlotte, N. C., branch of the Dixie Radio Supply Co. This new store was arranged for utmost convenience and efficiency.

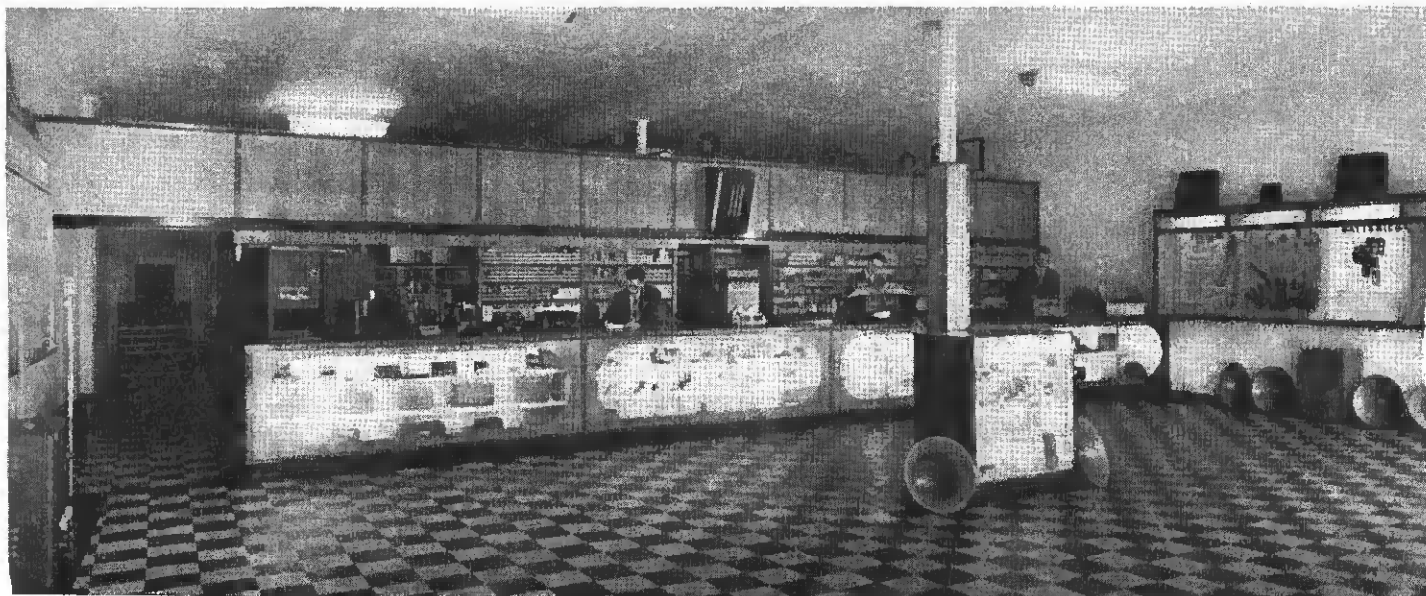

# SUPPLY LINES

## ng Under Fire of Scarcities. Dis- rvers' Groups Unite to Give Service

Florence R. Cutler, all Reading, Pa.

The members and guests heard George D. Barbey, NEDA president, give a detailed account about the 576,613 tubes his distributing firm purchased from an export company and which were later claimed by the Navy's Bureau of Ships, on high priorities.

### Tri-State Chapter Gathering

At the recent meeting of the Tri-State Chapter at the Hotel Roosevelt in Pittsburgh, members heard George D. Barbey, National NEDA president, describe the tube and parts situation, and there was a general discussion on the question of cooperative buying of surplus material. Those present were: F. L. Armstrong, Canton, Ohio; H. F. Morrison, Ashtabula, Ohio; Robert Kline, Tri-State Chapter president, Cleveland, Ohio; P. W. Wright and N. DiRosso, Steubenville, Ohio, and James Ross, Youngstown, Ohio. Also, J. A. Gettman, B. E. Gracroft, Charleston, W. Va.; J. H. Trenton, Morgantown, W. Va.; B. C. Mill, Clarksburg, W. Va.; William Fleming, St. Marys, Pa.; W. L. Hollenback, Altoona, Pa.; A. G. Wertz and P. G. Miller, Johnstown, Pa.; J. V. Duncombe, W. M. Schuster and M. Galinsky, Erie, Pa.; George C. Louys, J. T. Rose, E. J. Tyding, M. V. Mansfield, A. A. Bauer, Harry Caplan and Ed Lipka, all Pittsburgh, Pa.; Arthur Winter, Cleveland, Ohio, and George D. Barbey, Reading, Pa.

### Dixie Radio Supply Co. Moves Into New Store

The Charlotte, North Carolina, branch of The Dixie Radio Supply Co., Columbia, S. C., owned by Bennie W. Krell, is now occupying its new quarters at 912-14 So. Tryon Street. In designing the new store every possible consideration was made for future expansion in the electronic field.

The new store is about 42 feet wide, providing a very large showroom. One of the unique features of the display

room is the arrangement of fifteen individual displays in dust-proof glass cases, each illuminated by fluorescent lights. The counters and shelves back of the counters are used for display purposes only. Double shelves for the merchandise are built under the office and are not visible from the showroom. This makes the stock more accessible to the shipping department.

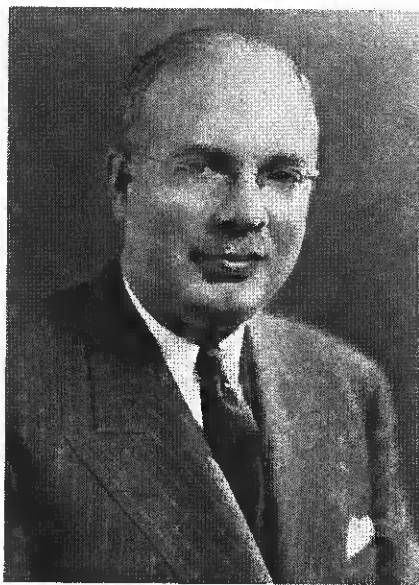

Charles G. Pyle, managing director, National Electrical Wholesalers Assn. Group grows under his leadership.

Dixie Radio Supply Co. is operated upon a strictly wholesale basis, and specializes in public address, sound and electronic equipment and radio parts and supplies. The Charlotte branch is managed by E. Kling Mueller. There are six other employees. One outside salesman covers the State of North Carolina.

### National Wholesale Group Plans For Postwar Period

Among the organizations working now on plans for the future is the National Electrical Wholesalers Assn. of which Charles G. Pyle is managing director.

Mr. Pyle has had broad sales and merchandising experience as general sales manager of Sylvania Electric



E. B. Ingraham, president of Times-Appliance Co., Inc., New York, heads appliance sub-committee on post-war planning for N. E. W. A.

Products, Inc., with whom he was connected for many years. He contributed the following interesting article upon the activities and aims of the Association:

"N. E. W. A. was organized in 1908 as the Electrical Supply Jobbers Association, changing its name to National Electrical Wholesalers Association just twenty years later. During all those years, it has served the electrical wholesaling industry constructively and uninterruptedly. It always has been and it still is the sole national Association of electrical wholesale distributors.

### Pay Convention Expenses

"N.E.W.A. conventions, usually held semi-annually, are national forums for discussing and considering the problems peculiar to the distribution of electrical supplies and appliances. Attended as they are by the principal officers of the manufacturers for whom the members distribute, the conventions are at the same time a most important contact point. In many cases, this is the only opportunity these members have to confer with these chief executives regarding mutual problems.

"These conventions also afford members, located in widely separated areas but who serve similar markets and operate the same types of busi-  
(Continued on page 64)



← Joe Pizzagone and Roberta MacGregor, record department instigator and manager, respectively. → View of the Oakland Radio Co. store from rear. Note records are right up front.

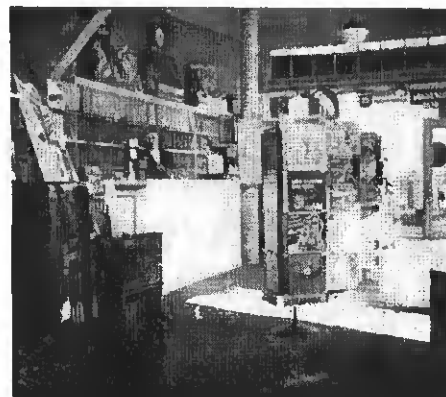

# Bread & Butter in Platters

**Records "Came to Dinner" with the Combinations and Remained to Stay . . . Now Platter Sales Soar, Hold and Pay for a Large Section of this Store**

Al and Joe Pizzagone, owners of the Oakland Radio Co., Oakland, Cal., have discovered that phonograph records can be more than a sideline to a radio retailer. They speak from wartime experience, from watching an "extra" develop into a business mainstay, a valuable prop for war-depleted stock.

Five years ago, as the radio-phonograph combination began to catch the public eye in earnest, the two brothers introduced phonograph records to their stock as a convenience for customers. This was not so much foresight as a willingness to try anything once. Record sales flourished modestly in a secluded corner of the store, tolerated despite the added bookkeeping they caused.

### Colorful Display

No more! Phonograph records have moved to the front of the store. Colorful albums are displayed in the windows and from revolving racks on the floor. The complete record library,

elaborately indexed, is presided over by Miss Roberta MacGregor, full-time attendant in that department. A display table, spread with an assortment of popular selections, is provided for customers who like to browse. Comfortable chairs and ashtrays stand ready for those listening to their choices. This gay, inviting atmosphere is the Oakland Radio Company's answer to wartime restrictions.

Records are filling the gap left by the absence of new radio set sales. Co-owner Al Pizzagone states: ". . . records are doing all right by us and we're thankful for them."

### Used Radios Offered

Overhauled and guaranteed used radios, and service on radios and appliances make up the balance of business at the Oakland Radio Co. The dwindling supply of first-class parts is, of course, a problem in this shop as in others. "After parts are gone," the brothers agree, "we'll find out

who wants to hire a couple of experienced radio technicians!"

The boys feel fortunate to have one radio technician, Robert Morgan, still working with them in the shop.

### Brothers Are Pioneers

Since radio was a fledgling, Al and Joe Pizzagone have been keeping pace with progress from the same spot. When the Oakland Radio Co. building housed station KLS, a pioneer radio station in California, the boys worked in the store. When KLS, then a 5-watt plant, took on a 1,000-watt transmitter and moved to larger quarters, the Pizzagone brothers bought the store, turned the old studio into a repair shop and sold parts for home made sets out in front.

"We've watched revolutionary changes in this business," the brothers say philosophically. "This war is another change. When peace comes, we'll see progress that'll make your head swim. We'll just wait around for that time. It'll come."

Pioneer radio brothers Al and Joe Pizzagone found an "extra" in records that developed into a business mainstay.

Record manager Roberta MacGregor proved the added bookkeeping was no hindrance to present record successes.

Oakland Radio Co. store from the front. Note the attractive display records add to an already goodlooking shop.





*an*  
**EYE**  
*to*  
*the*  
*future*

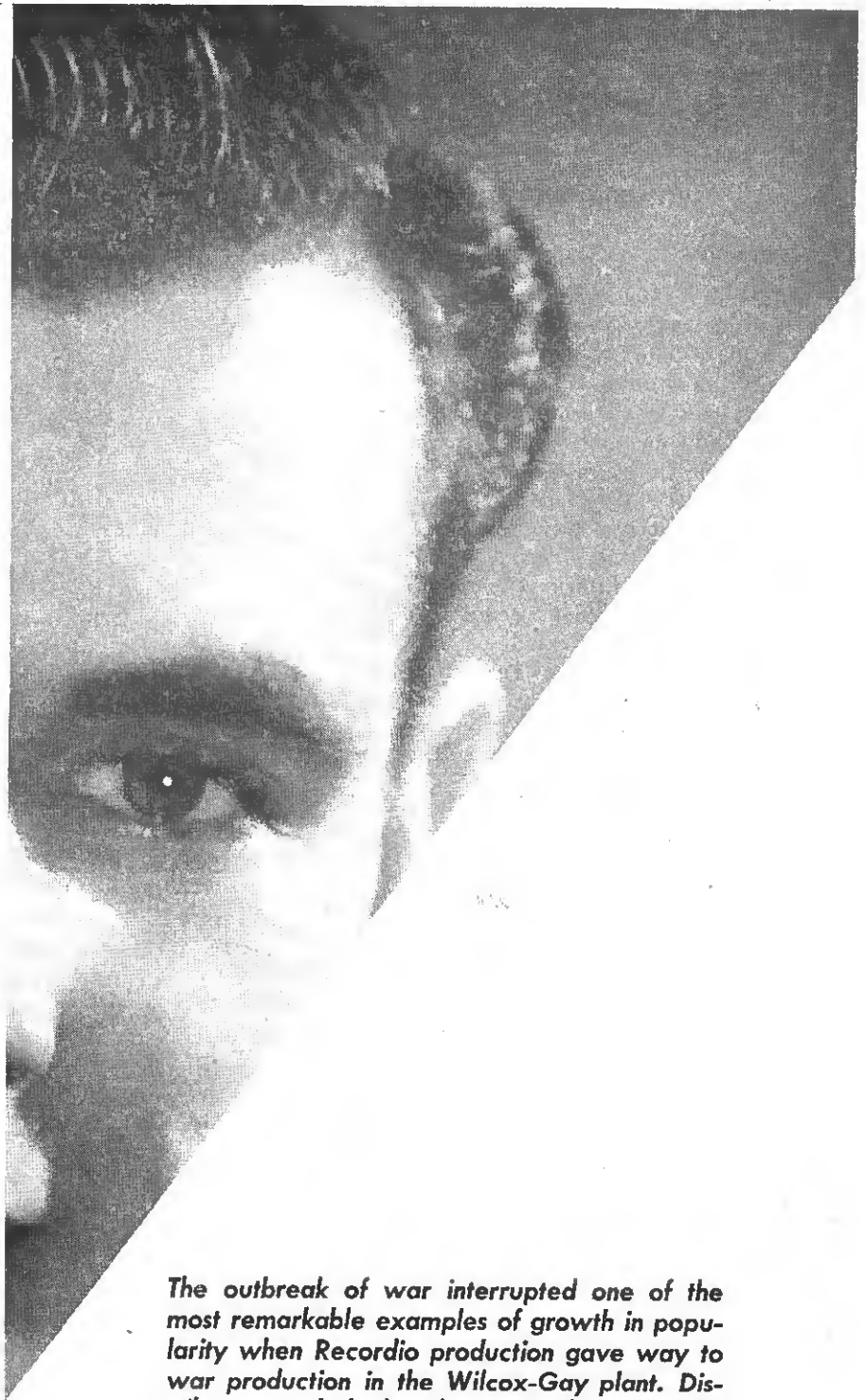

*The outbreak of war interrupted one of the most remarkable examples of growth in popularity when Recordio production gave way to war production in the Wilcox-Gay plant. Distributors and dealers have not forgotten the sensational success of the Recordio. And they may rest assured that Wilcox-Gay has an eye to the future that will bring a new, more sensational Recordio, the original home recording-radio-phonograph combination.*



**WILCOX-GAY CORPORATION**  
CHARLOTTE, MICHIGAN

**Manufacturers of the Recordio, Famous Home Recording-Radio-Phonograph Combination**

# Records on "RESERVE"

*Chicago Radio Dealer Finds Reservation System Speeds Turnover*

● The M. E. Hollander Radio Electric Shop, 2702 W. North Ave., Chicago, Ill., is doing a rapid-fire, profitable business in records. Either by deposit—as small as 25c—or payment in full, customers may reserve in advance the records they want, and Mr. Hollander has his entire stock almost completely "sold" before it reaches the store!

A counter sign informs customers of this service, and four typewritten sheets of 20 selections each, headed Hit Parade, Old Time Favorites, Cowboy Songs, and Novelty Numbers are constantly on view for the cus-



Pictures on this page show the store and window arrangement. Note records are displayed wherever possible at eye-level. Originally radio and electrical dealer, Mr. Hollander has also added a gift line of pottery, glassware, picture frame placques and toys. His specialty, however, is the record department with its affiliated sheet music section, and he reports that record sales are zooming!

tomers to make his selections from. This listing also affords dealer Hollander an accurate check on just how fast various numbers are moving.

This store does equally well with the classics and populars. The present inventory is about \$5000. Uncalled for "reserves" are quickly absorbed by stray shoppers. This amount is estimated at less than 1 per cent. Deposits, of course, are forfeited in this event.



# PHILCO

P R E S E N T S

## *The Radio Hall of Fame*

for the first time in history—a Radio Review of the best in all fields of entertainment—a full hour program of proven hits, judged and selected by *VARIETY*, leading authority of the show world.



**What the Academy Award is to the movies... what the Rose Bowl is to football... what the Reader's Digest is to the magazines...**

**THE RADIO HALL OF FAME will be to the world of entertainment.**

On Sunday December 5, 1943, from New York and Hollywood, a sensational new program came to the air. All-star entertainment, famous names and outstanding artists... but more than that, a brand new *service* for the radio listeners of America!

How often have you wished that some competent judge would pick out the best performances, the top hits, the shows you shouldn't miss and present them to you all in one single program?

Nothing like it has ever been done before; yet it meets the expressed or unexpressed wish of millions throughout America. And now it's here, for the first time in the world of entertainment... presented to you on the air by Philco... the Radio Hall of Fame!

Every week, *Variety Magazine*, the leading authority and most influential publication in the show world, will comb the theatres, concerts, studios, night clubs and popular

song centers in every part of the country. And every week *Variety's* board of editors will judge and select *the best*—the top hits—the performances that make headline news, nationally and locally—for the Radio Hall of Fame.

Thus, by its very nature, this radio show of shows produces the greatest program of all-star entertainment ever conceived. Because every act is *a hit*, tried and proven.

In launching the Radio Hall of Fame now, Philco looks to the greater Philco of tomorrow—now building through war research and production. When peace returns, the products that Philco will provide in radio, phonographs, television, refrigeration and air conditioning, will bring to Philco dealers the greatest opportunities ever offered in the appliance trades.

*Tune in Every Sunday*

**BLUE NETWORK**  
**Coast to Coast**

6 to 7 P.M. ... Eastern War Time  
5 to 6 P.M. ... Central War Time  
4 to 5 P.M. ... Mountain War Time  
3 to 4 P.M. ... Pacific War Time

# Library of the Composers

Some Pointers for Your Customers Who Want to Collect Compositions of the Great

• The novice usually finds it hard to know where to begin. A music collection on discs can be a thing of permanent pleasure and enjoyment, and thoroughly worth the sizeable investment it should eventually require. What to buy first is often the initial sales hurdle. Lack of a definite plan for extending the library sometimes is the stumbling block in further sales.

A good starting point, we suggest, is that this customer include at least one of the most noted works of each of the outstanding composers throughout musical history. Once these albums have been acquired, their lesser known works may be added.

Below we have reproduced a chart which came to our desk recently, which shows the great composers' lives—from Bach to Gershwin—arranged

chronologically. This chart is the result of the work of Otto K. Eitel, manager of the Bismarck Hotel in Chicago, and music lover. It has received the plaudits of famous musicians, who acclaim it the most unusual contribution to musical literature they have seen in many years. Mr. Eitel had the assistance of Dr. Hans Rosenwald of the Chicago Mu-

(Continued on page 32)

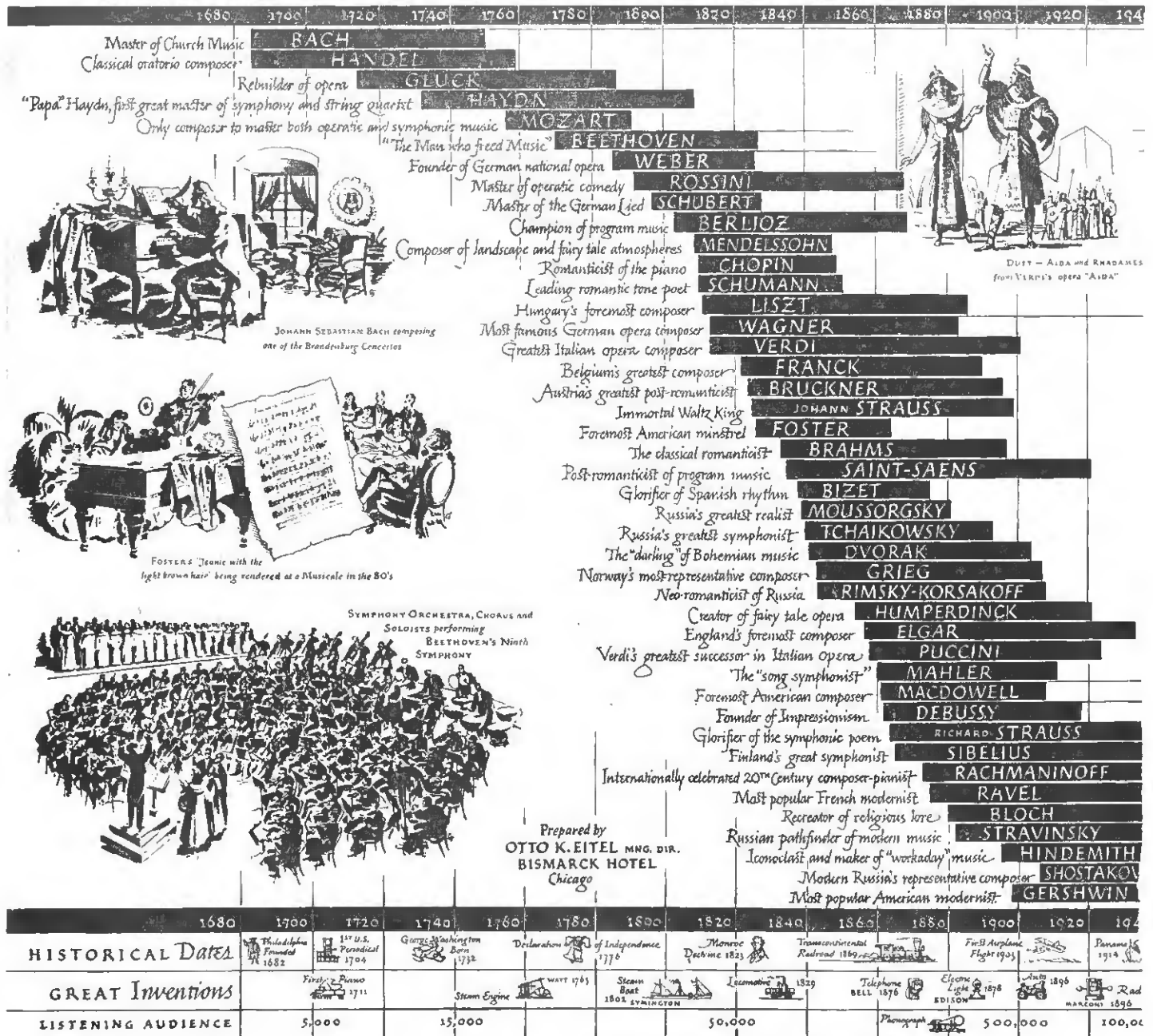

# A SHORT STORY *for* RADIO DEALERS

## YESTERDAY

there were two radio companies doing a very creditable job of manufacturing and selling. Mission Bell Radio Manufacturing Co. was producing medium and inexpensive table models, as well as commercial communication equipment.

Mitchell-Hughes was creating a well-earned reputation as one of the nation's finest custom-built phonograph-radio combinations.

## TODAY

these companies combined in Hoffman Radio are successfully executing some of Radio's toughest war assignments. We've acquired the finest radio engineering staff obtainable and highly trained our people to manufacture fine precision products in mass production and at low costs.

## TOMORROW

radio dealers may have implicit confidence in our capacity to build any type of postwar radio equipment the public will buy. We invite your interest in the future of this company.



## ONE OF RADIO'S TOUGHEST ASSIGNMENTS

Among our war responsibilities is the manufacture of an indispensable electronic device requiring more than 4000 calibrations to 1/100 of 1% accuracy over the widest temperature ranges in Alaska or Africa. It assures accurate communication contact with all Navy units on ships, shore or planes.'

# Hoffman

RADIO CORP.

MANUFACTURERS OF MISSION BELL RADIOS . . .  
MITCHELL-HUGHES PHONO-COMBINATIONS . . .  
ELECTRONIC AND COMMUNICATION EQUIPMENT

3430 SOUTH HILL STREET • LOS ANGELES 7, CALIFORNIA

# LIBRARY OF THE COMPOSERS

(Continued from page 30)

sical College in the compilation of this chart.

In line with this listing, we are carrying the thought further by indicating a representative work by each of these great composers which record dealers may care to recommend to their customers:

- BACH—Arioso  
 HANDEL—The Messiah  
 GLUCK—Orpheus  
 HAYDN—Symphony 101 in D Major (The Clock)  
 MOZART—The Magic Flute  
 BEETHOVEN—Concerto No. 5 in E Flat (Emperor)  
 WEBER—Invitation to the Waltz  
 ROSSINI—Barber of Seville  
 SCHUBERT—Unfinished Symphony  
 BERLIOZ—Symphonie Fantastique  
 MENDELSSOHN—Midsummer Night's Dream  
 CHOPIN—Chopin Waltzes  
 SCHUMANN—Symphony No. 3 in E Flat (Rhenish)  
 LISZT—Hungarian Rhapsody  
 WAGNER—Tannhauser  
 VERDI—Aida  
 FRANCK—Symphony in D Minor  
 BRUCKNER—4th Symphony (Romantic)  
 JOHANN STRAUSS—Strauss Waltzes  
 FOSTER—Collected Works  
 BRAHMS—Piano Concertos  
 SAINT-SAENS—Carnival of the Animals  
 BIZET—Carmen  
 MOUSSORGSKY—Boris Godounoff  
 TCHAIKOVSKY—Symphony No. 5 in E Minor  
 DVORAK—Symphony No. 5 in E Minor  
 GRIEG—Peer Gynt  
 RIMSKY-KORSAKOFF—Scheherazade  
 HUMPERDINCK—Hansel and Gretel  
 ELGAR—Pomp and Circumstance March  
 PUCCINI—La Boheme  
 MAHLER—The Song of the Earth  
 MACDOWELL—To a Wild Rose  
 DEBUSSY—Prelude to the Afternoon of a Faun  
 RICHARD STRAUSS—Don Quixote  
 SIBELIUS—Symphony No. 5 in E Flat Major

- RACHMANINOFF—Prelude in C Sharp Minor  
 RAVEL—Bolero  
 BLOCH—Concerto Grosso for Piano and String Orchestra  
 STRAVINSKY—Firebird Suite  
 HINDEMITH—Matthais The Painter  
 SHOSTAKOVICH—Age of Gold Ballet  
 GERSHWIN—Porgy and Bess

The foregoing compositions have been recorded in one form or another and are to be found in the catalogues of the large recording companies. If a customer includes these basic pieces he will have a library rich in beauty and lasting enjoyment, and which should be the basis for further interest and search in the record field.

These recordings, however, represent quite a large investment. We suggest that once you interest your purchaser in acquiring a record library, you work out some plan for him whereby he can buy certain of these selections each month, according to the amount of money he wants to spend.

There are 43 composers listed above. Add at least 24 outstanding good popular albums, using plenty of variety, from such as: the music of Rudolph Friml, Jerome Kern, Noel Coward, Cole Porter, Rodgers and

Hart, Duke Ellington, George M. Cohan, Irving Berlin, Sigmund Romberg—albums that include the show hits, old and new. Consider, too, the inclusion of dramatic readings. Don't forget to intersperse living music of the various nations—songs of Russia, China, etc.

Make up a list of your own for each month in the year. Include at least two of the recommended classics, to give the library authentic beauty and educational quality. Add several of the "sweet-tune" albums of the best show writers for color. Suggest some of the current choral albums of the songs of other countries for news interest. Intersperse readings, calypso music, South American dance records for drama, pep and spice. And you'll have a list that customers of all tastes can choose at least 5 albums each from, monthly, and wind up at the end of the year with a well balanced, colorful and educational record collection that will be worth many times the original investment.

Promote the record library to your customers. It not only means current revenue for you, but keeps them coming back to buy. You will get to know your customers' tastes better through each one's monthly selections. The customer, in turn, will appreciate and remember you for your interest.

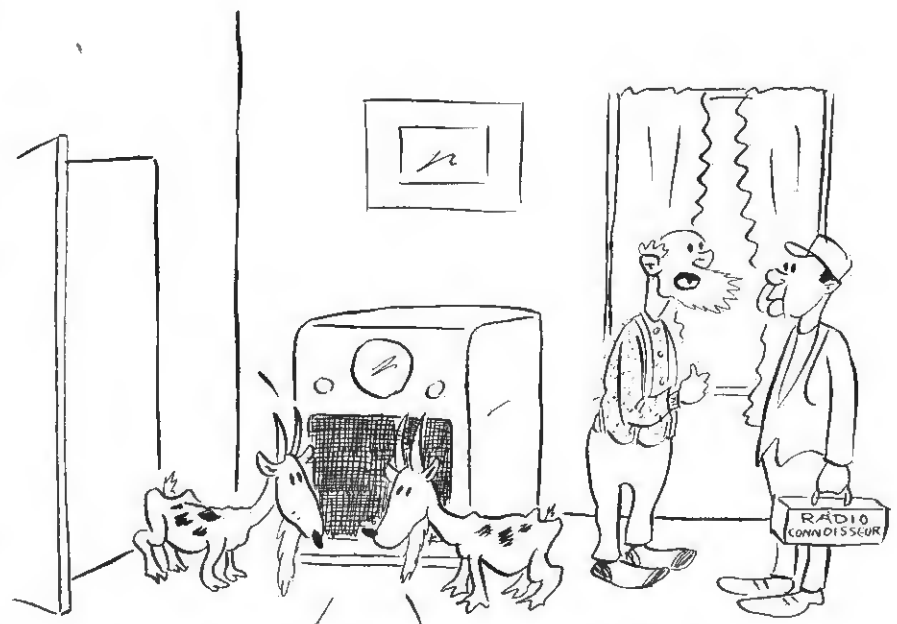

"See what I mean when I say it sounds tinny?"

EVERYONE IS TALKING ABOUT THE NEW *Electro-Voice* ACHIEVEMENT  
**NICKNAMED THE "LIP-MIKE"**



Officially known as the T-45, the

*Electro-Voice*

**DIFFERENTIAL MICROPHONE**

is also affectionately termed the "Schickelgruber"

Developed by Electro-Voice engineers in close collaboration with the Fort Monmouth Signal Laboratory, the T-45 marks the beginning of a new era in which voice transmission is unaffected by ambient noise or reverberation. It accomplishes such complete suppression of background that speech from a battlefield or from the deafening interior of a moving tank is accompanied by hardly a trace of noise.

The "Lip-Mike" is a Differential Microphone designed to fit under a gas mask without breaking the seal — small enough to allow an Armored Force respirator to slide over it — and has been standardized for all Army Ground Forces.

- ◆ Frequency response substantially flat from 200-4000 cps.
- ◆ Low harmonic distortion
- ◆ Cancellation of ambient noise, but normal response to user's voice
- ◆ Self-supporting, to free both hands of the operator.
- ◆ Uniform response in all positions
- ◆ Usable when gas mask, dust respirator or oxygen mask is required
- ◆ Unaffected by temperature cycles from  $-40^{\circ}$  F. to  $+185^{\circ}$  F.
- ◆ Ability to withstand complete immersion in water
- ◆ Physical strength to withstand 10,000 drops
- ◆ Weight, including harness, cord and plug, less than 2 ounces.

WHEN PEACE COMES, THERE WILL BE DIFFERENTIAL MICROPHONES OF MANY TYPES FOR CIVILIAN USES IN WHICH THESE ADVANTAGES WILL BE OF REVOLUTIONARY IMPORTANCE. THUS, ANOTHER WARTIME DEVELOPMENT WILL FIND ITS GREATEST VALUE IN THE COMING OF PEACE.

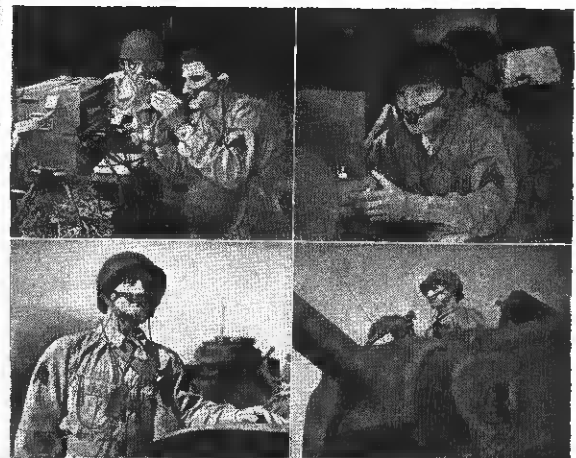

*Electro-Voice* MICROPHONES

ELECTRO-VOICE MANUFACTURING CO., INC. • 1239 SOUTH BEND AVENUE • SOUTH BEND, INDIANA  
 Export Division: 13 East 40th Street, New York 16, N. Y. — U. S. A. Cables: ARLAB

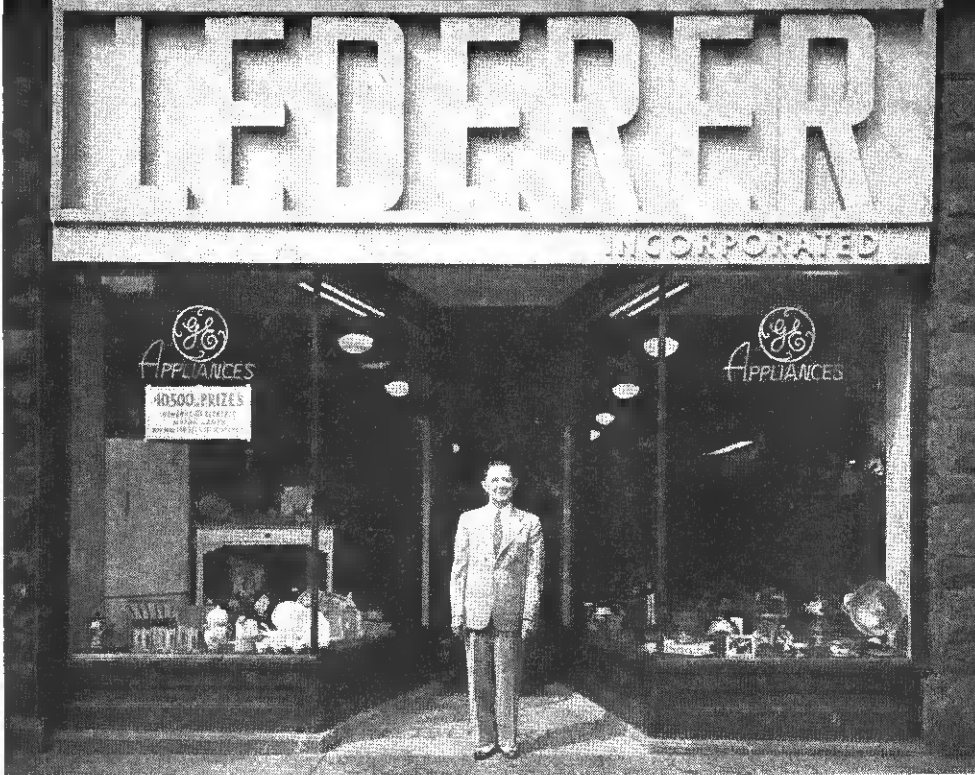

President Lederer before his well stocked store. Business is good!

“moving” public’s preference for the small set.

This dealer is eagerly awaiting news of the manufacturers’ postwar policies. He sincerely hopes that the retailer will be protected against accumulation of “old” models. Believes an answer to this might be to deal with *one* manufacturer only. This has its added advantages, he claims, in that it would promote better knowledge of *all* of a manufacturer’s products, save salespeople’s time, simplify inventory, and promote better dealer-manufacturer relationship.

Further, Mr. Lederer would like to see less models of the same article from each of the manufacturers. This, he believes, should lower manufacturing costs, provide better ma-

# The MAJOR and the MINOR

**Current Shortages No Threat to This Refrigerator, Radio & Appliance Specialist—Holds Pre-War Customers with “Tide-Overs”**

• Joseph H. Lederer, president of Lederer, Inc., Bridgeport, Conn., electrical dealer, reports that during the pre-war period his biggest dollar volume of sales was in refrigerators. Today, to augment these sales, and those of his complete scale of the major and the minor appliances he carried, he has added a most ingenious list of items:

- |                        |                          |
|------------------------|--------------------------|
| Breakfast Sets         | Heat & Sunlamps          |
| Brushes & Mops         | Kitchen Sinks & Cabinets |
| Carpet Sweepers        | Lamps                    |
| Clocks                 | Leg-O-Matic Sets         |
| Coal Heaters           | Oven Ware                |
| Coffee Makers          | Pyrex                    |
| Coolerators            | Record Players           |
| Dinner Ware            | Scales                   |
| Flags                  | Soldering Irons          |
| Gas Ranges             | Stainless Steel          |
| Gifts                  | Cutlery                  |
| Glass Cooking Utensils | Wagons                   |
| Glass Ware             |                          |

It is interesting to note that dealer Lederer has added those items which duplicate as nearly as possible the currently missing electric appliances.

Instead of losing contact with a former customer who currently wants a vacuum cleaner, this retailer offers a carpet sweeper to tide the customer over the “duration” period. When electric cleaners are again on the market, Lederer already has the name of John Q. Prospect in his file,

with the fact that he will be needing one of the first of the new models!

In business for many years at his present stand at 1015 Broad St., this merchandiser was one of the first to take on radios in addition to appliances. He pioneered in the sale of radio—merchandised the large expensive set first to all prospects, then concentrated on the same persons in promoting the idea of more than one radio in the home—the need for an extra small set in the kitchen, bedrooms, sunroom, and playroom. Still has some large sets in stock, mainly, he claims, because of the current

material and workmanship, and justify maintaining retail prices.

Radio and appliance repairs previously an outstanding feature at Lederer’s, are now limited to what one part-time servicer can handle, which confines this department to service for Lederer’s customers.

Mr. Lederer’s final plea to the post-war manufacturer: Don’t bring out numerous models which differ too slightly, too frequently! If a model is *superior* to a previous one, fine; but PLEASE, Mr. Manufacturer, not a dozen models that aren’t worth the differentiation!

Mr. Lederer and his able assistant, Mrs. Lederer. That photo shows their son.







## TOUGH CUSTOMERS!

As the enemy often has discovered to his cost, planes marked with the star of Uncle Sam are pretty tough customers to argue with up there in the sky. That's partly because the old gentleman with the beard and the star-spangled hat knows how to be tough in buying the equipment that goes into these planes.

In engineering, materials and workmanship, he insists on the best. And in the electronic equipment produced here at Belmont, we see that he gets it.

This experience in pleasing the world's most critical customer will, one day, be turned full force to the production of radio and allied equipment that will be equally sure to please millions of customers all over the world. Belmont Radio Corp., 5921 W. Dickens Ave., Chicago 39, Ill.

 **Belmont Radio**  
TELEVISION ★ FM ★ ELECTRONICS

# COOKING by WIRELESS

Magnetic waves radiating from this cold range-top induce in the metal of the utensils currents of thousands of amperes. These self-contained eddy-currents quickly heat utensil and food.

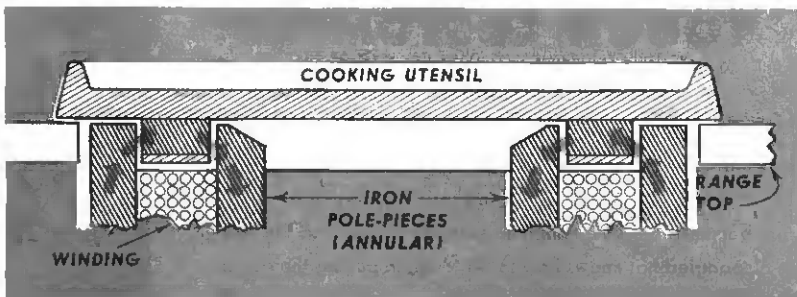
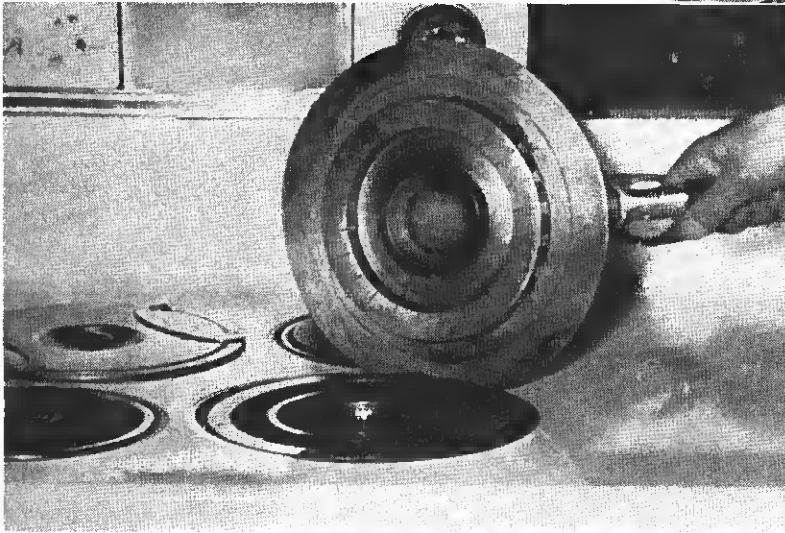
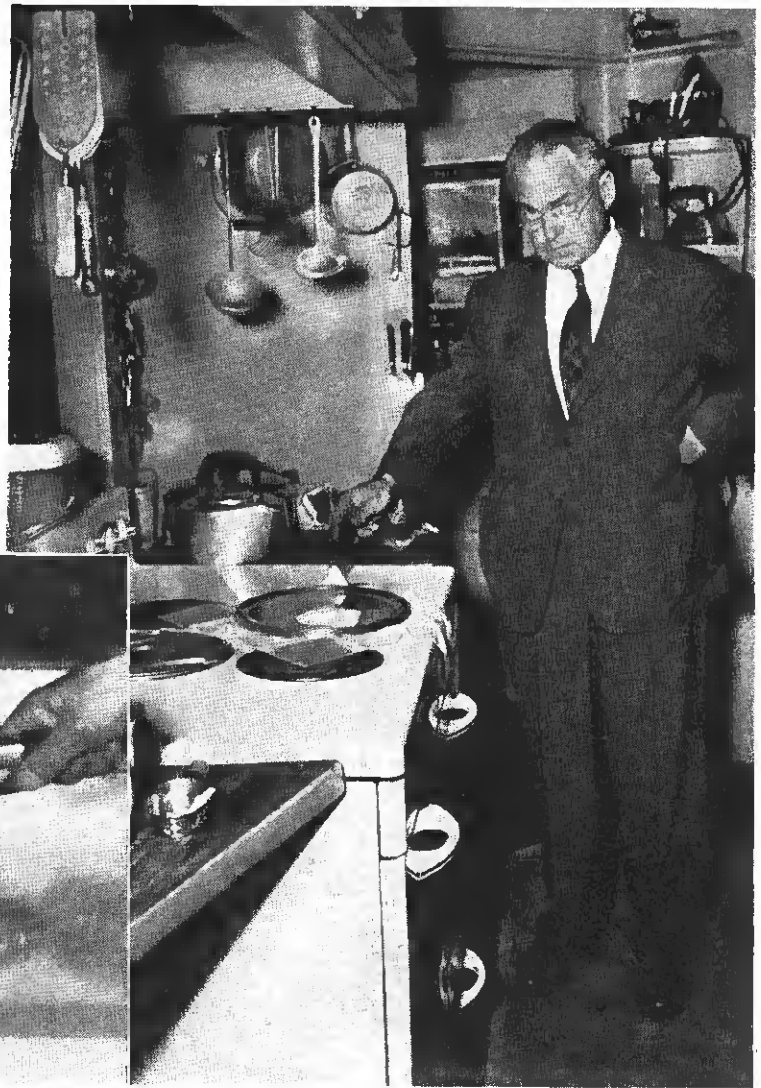

This novel form of magnetic induction cooking has been in use in the Cos Cob, Conn., Kitchen of O. H. Caldwell, editor of *Radio Retailing Today*, for the last three years. Presaging the day of high-frequency induction cooking, these 60-cycle 5,000,000-meter magnetic waves have proven themselves far faster and more economical than the usual resistance heating elements (with which the kitchen is also equipped).

*Photos by Newsweek*

Diagrammed above is the magnetic structure, showing how 60-cycle magnetic pulsations from the open-ended transformer cores surge through iron pole-pieces in the utensil bottom, causing eddy currents to circulate in the aluminum mass of the utensil.

In principle, the operation of this wireless cooking outfit exactly corresponds to the energization of a radio receiver by a distant radio transmitter. The transformer in the range-top is the transmitter of 60-cycle magnetic waves; the utensil corresponds to the receiver.

Right—To prove the truly "wireless" character of this cooking operation, the napkin was first laid on the range-top, then the frying-pan was placed on top of the napkin. All the energy to fry the eggs comes through the napkin not as heat but as magnetic waves.





## Is he on your Christmas list?

*There are many ways in which you can remember him now and in the months ahead.*

**V**ISIT your blood bank—not just once, but as often as you can. Blood plasma may save his life—on some battle-torn field.

Buy War Bonds every payday—as many as possible—dollars are needed to give him the weapons he requires to achieve Victory.

Give generously to the USO, the Red Cross and other agencies. They can make the difference between a lonely soldier and a happy one.

**PARTS FOR RADIO, ELECTRICAL AND ELECTRONIC DEVICES, INCLUDING SPEAKERS, TRANSFORMERS, VIBRATORS, VITREOUS ENAMELED RESISTORS, WIREWOUND CONTROLS, PLUGS, JACKS, SWITCHES, ELECTRIC MOTORS**

**CABLE ADDRESS: UTARADIO, CHICAGO**

RADIO Retailing TODAY • December, 1943

Co-operate with Civil Defense authorities—a nation is only as strong as its home front.

And do your job—no matter what it is. Work—and work hard for Victory.

That's what you can do for this soldier—what you can do to help bring him home sooner to really enjoy the many merry Christmases to come.

UTAH RADIO PRODUCTS COMPANY, 810 Orleans St., Chicago, Ill. Canadian Office: 560 King Street West, Toronto. In Argentine: UCOA Radio Products Co., S. R. L. Buenos Aires.





Something new for Owner M. L. Marks, shown above in his Baton Rouge Radio & Electric Co. store. He opened his eyes and found a new line at his doorstep. Uses plenty of display as sales magnet for fussy fishermen!

## ***Baits New Customers With Fishing Tackle!***

• Fishing tackle is proving a profitable side-line for Baton Rouge Radio & Electric Co., Baton Rouge, La. M. L. Marks, owner, said he took on the line about two years ago when radios and other electrical appliances became scarce on account of the war.

It wasn't such a strange transition for Mr. Marks, since he has been a fisherman all his life, and Baton Rouge is on the lower reaches of the Mississippi River in a sort of fisherman's paradise. He bought up a big stock of rods, reels, artificial lures, and sportsmen's wearing apparel in the beginning, and has been able to replenish the stock all along, although this merchandise is now somewhat scarce.

### **Winning Combination**

The concern continues its considerable radio service business, and Mr. Marks finds it works well with fishing tackle sales, which he finds are

***This is No Fish Story! Inspired by His Louisiana Locale Where Much Fishing and Camping Is Done, M. L. Marks Will Augment Future Radio & Appliance Sales with Fishing and Camping Equipment Plus Portable Radios for Campsite Use***



best in Sunnertime, while the bulk of radio repairs come in the Winter.

The small tackle merchandise also creates more traffic for his store, and he likes that. Therefore, after the war, he says he plans to continue to operate a combined sporting goods and radio store. He believes it will be a winning combination.

### **Plans for Future**

"The electric specialty store needs other items to draw traffic," said Mr. Marks, "and I believe in my location on the river and in a lakes country, sporting goods offer the answer. Anyhow I like to dabble with the line. I will of course continue to handle radios and other small appliances. In the future, I will specialize in small radios and will feature portable sets suitable for use by campers and fishermen. And who knows—I may offer the fisherman an electronic-operated rod and reel."



*Attack Signals MUST Get Through*  
*... the SUPER-PRO "SERIES ♦ 200"*

**W**HERE there is an important job to be done—where absolute dependability is essential—where vital messages are counted on to come through at precisely the right moment, there you'll find a "SUPER-PRO". And well chosen, too, for engineers know they can rely on the "SUPER-PRO".

THE HAMMARLUND MFG. CO., INC.  
 460 West 34th Street, New York, N. Y.



**HAMMARLUND**

# REFRIGERATOR

# SELLING

• In the inauguration of new designs and mechanical features, manufacturers of electric refrigerators must take into consideration the difference between men and women as buyers, and must in the future, as they did in the past, angle their features two ways accordingly.

Years of customer contact have taught refrigerator salesmen these facts:

## Most men buy on:

1. Reputation of the maker, and the retailer.
2. Guarantee terms.
3. Mechanical features they are able to comprehend, cabinet construction and finish.
4. Economical operation cost.
5. Price, payment plan and inducements (trade-ins, etc.)

## Most women buy on:

1. *Familiarity* with name of maker.  
(Note reputation of dealer not important, and "familiarity" with name of maker generally obtained from friends or relatives owning the make; through advertising, etc.).
2. Exterior eye-appeal. Color, styling, hardware and methods of door-opening.
3. Eye-appeal (interior cabinet) shelf arrangement, accessories and gadgets; ice-cube capacity.
4. Price, payment plan and inducements, guarantee features.
5. Mechanical features: Chiefly automatic or semi-automatic defrosting controls and freezing speed claims.

Doubtless, for some time after the war, dealers will have the good old familiar models they were selling just before the war—and they were and still are tops in every way—innovations will come later.

In the meantime, buyers remain the same—except that there's nothing

## Ready to Pick Up Where It Left Off . . . Manufacturers Help Sales Picture

for them to buy *now* in refrigeration. But *tomorrow*—with so many obsolete refrigerators to replace, and with the prodigious number of people who have never owned mechanical refrigeration clamoring for it the picture is pleasant for *Radio Retailing Today's* dealer-readers to look at.

What will be new in design and performance of electric refrigerators some time after the war will, in a great measure, govern future distribution and selling techniques. However, in the immediate postwar period, certain fundamentals we've known in the past will continue to apply to sales to the consumer.

## Makers Made Sales Easier

With prospects of selling the same models immediately after the war, dealers all over the country are getting set to *resume* business along fa-

miliar lines without many changes.

Many of the complications formerly associated with the selling of electric refrigerators had been ironed out shortly before production ceased.

For instance, the refrigerator manufacturers received plaudits from the dealers when they made a drive to eliminate a lot of in-between size boxes. Selling was simplified all over the country as a result. Salesmen concentrated on the six-foot size, and in one fell swoop eliminated 75 per cent of customer indecision by recommending the six-footer as the "average family" size.

Prior to general customer acceptance of this size refrigerator, there was a big element of annoyance and expense involved in exchanging newly purchased boxes for ones of larger size. The picture was hardly ever reversed. The purchaser generally bought the smaller box because of the lower price, and finding it too small, demanded an exchange—at the expense of the dealer.

## An Expensive Operation

As most of these refrigerators were sold on time payment plans, the expense not only involved hauling, but also the revamping of existing contracts, and correspondence between the dealer and the finance company, or bank holding the paper. Therefore, when manufacturers commenced stressing the "larger size" refrigerator in their advertising, they performed a valuable service to the retailer.

Seemingly the only objection a few customers had in being influenced to buy the larger size lay in their belief that this size cost much more to operate. A clever salesman, however, did not have much difficulty in overcoming this obstacle.

Of course, too, there were instances where a small size refrigerator just had to be because of lack of space. This held true in a number of very old homes, and in some small, cheaply constructed ones.

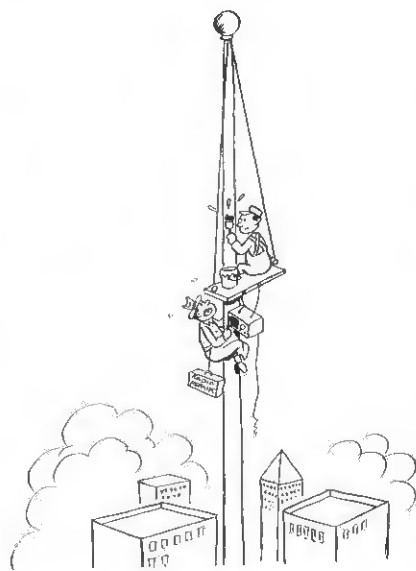

"After this you'll have to bring your radio to the shop when it needs repairing!"

# Faithfully Yours

The familiar Triplet trademark stands as a pledge of long service for those who require instruments that *faithfully* retain their accuracy over the years. Engineers realize the importance of Triplet contributions in making better instruments. In Triplet laminated magnet construction, for example, exclusive methods give permanency and provide for uniform scale linearity. Scientific heat-treating in automatic furnaces, followed by peening of each lamination, and the use of selected "cut-off" segments insure uniform standard printed scale accuracy. Careful ageing of all magnets follows to provide unchanging permanency of strength.

THE TRIPLET ELECTRICAL INSTRUMENT CO. • BLUFFTON, OHIO

**Buy More  
War Bonds**

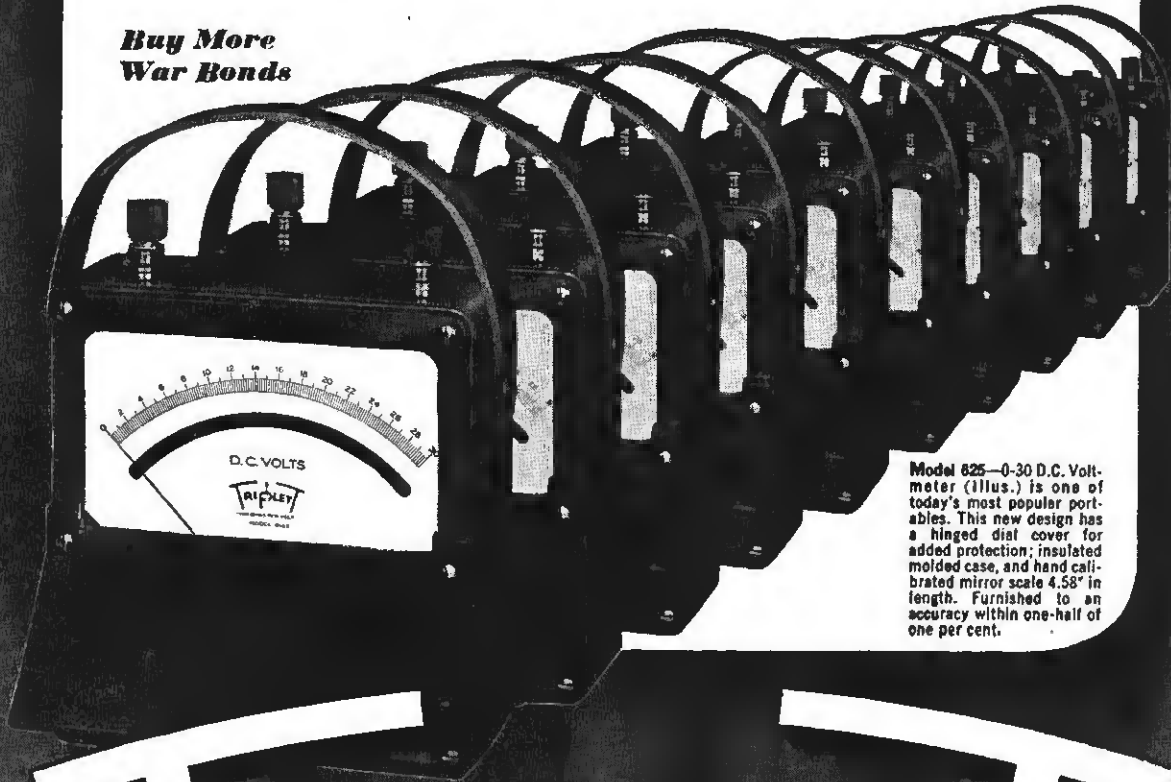

Model 825—0-30 D.C. Voltmeter (illus.) is one of today's most popular portables. This new design has a hinged dial cover for added protection; insulated molded case, and hand calibrated mirror scale 4.58" in length. Furnished to an accuracy within one-half of one per cent.

# TRIPLET

ELECTRICAL MEASURING INSTRUMENTS  
RADIO AND INDUSTRIAL TEST EQUIPMENT



Paul Frank (front) and his partner, Ellis Zorwitz, make their refrigerator sales future come true by working on repairs now. Owners of the Embassy Radio & Electric Appliance Co., Mt. Vernon, N. Y., they specialize in fast service.

**No Crystal-Gazing Here  
These Appliance Repair  
Men Will Sell Refrigerators  
to the New Market!**

finds very little trouble with late model refrigerators, but plenty with the old-timers. They keep a number of replacement motors on hand, and have contact with a good motor repair shop also, where they get speedy work of all sorts done.

Work on washers is also an important phase of service in this shop, and in this field also, Embassy is building up lots of good will and lots of prospects.

The setup employed here is interest-

# Refrigerator Idea Men

• The best way to insure postwar refrigerator sales volume is to render the best possible service now—and to as many people as the shop can handle.

That's the advice Paul Frank and Ellis Zorwitz, owners of Embassy Radio & Appliance Co., 164 E. Third St., Mt. Vernon, N. Y., have to offer. Under this apparently simple formula there is a strong foundation for future business. First, declare the partners, the service rendered is profitable. Second, through service rendered in so many homes, they know *who* needs replacements, thus building up a first-class prospect list.

All makes are serviced by Embassy. Before production ceased, they were important Frigidaire dealers, and they also did a big business in radio and in various other appliances. Today, with radio and refrigerator service piled up around them, the Embassy partners have no desire to stock alternate lines of any kind.

"We want the people to remember us as appliance dealers and servicers, exclusively," declared Mr. Frank.

It is a well-known fact that the refrigerator service situation has been

and is acute, but Paul Frank and Ellis Zorwitz have been rendering two to three day service as a general rule, where many other organizations were two to three weeks behind in their calls.

According to Embassy's owners, many new techniques have been employed as wartime measures. For example, Mr. Zorwitz says that they have satisfied many customers through rendering emergency service pending the job completion. "Where it has been necessary for us to hold up a job longer than a few days, we have suggested to the customer that he use 'dry ice' to keep the refrigerator contents from spoiling."

The customer is sent to the nearby "Good Humor" plant, where a big chunk of the dry ice can be procured for twenty-five cents. This is wrapped in paper and is placed in the chill tray. As a possible source of supply, the Embassy owners advise that a number of candy and soda stores have "dry ice" for sale.

Embassy Radio & Appliance Co.

**Technicians Frank and Zorwitz in their radio laboratory.**

ing. The showroom is attractively decorated, and exhibits a few appliances now. The radio repair shop is partitioned off at the rear. The refrigerator and washing machine repair department is in a nearby building. An efficient intercommunicator system between the two places saves many steps.

*(Continued on page 68)*

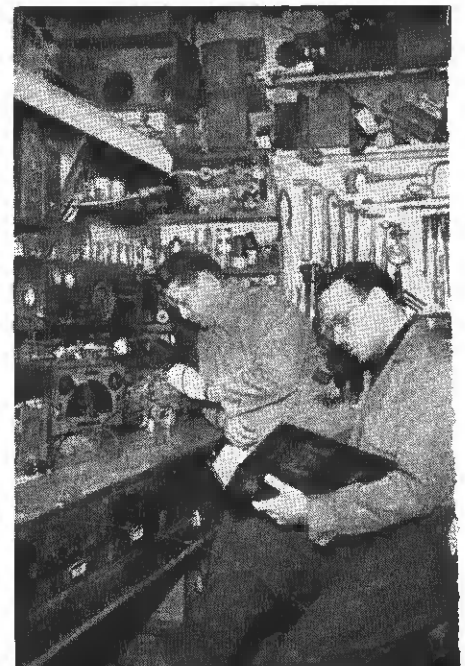



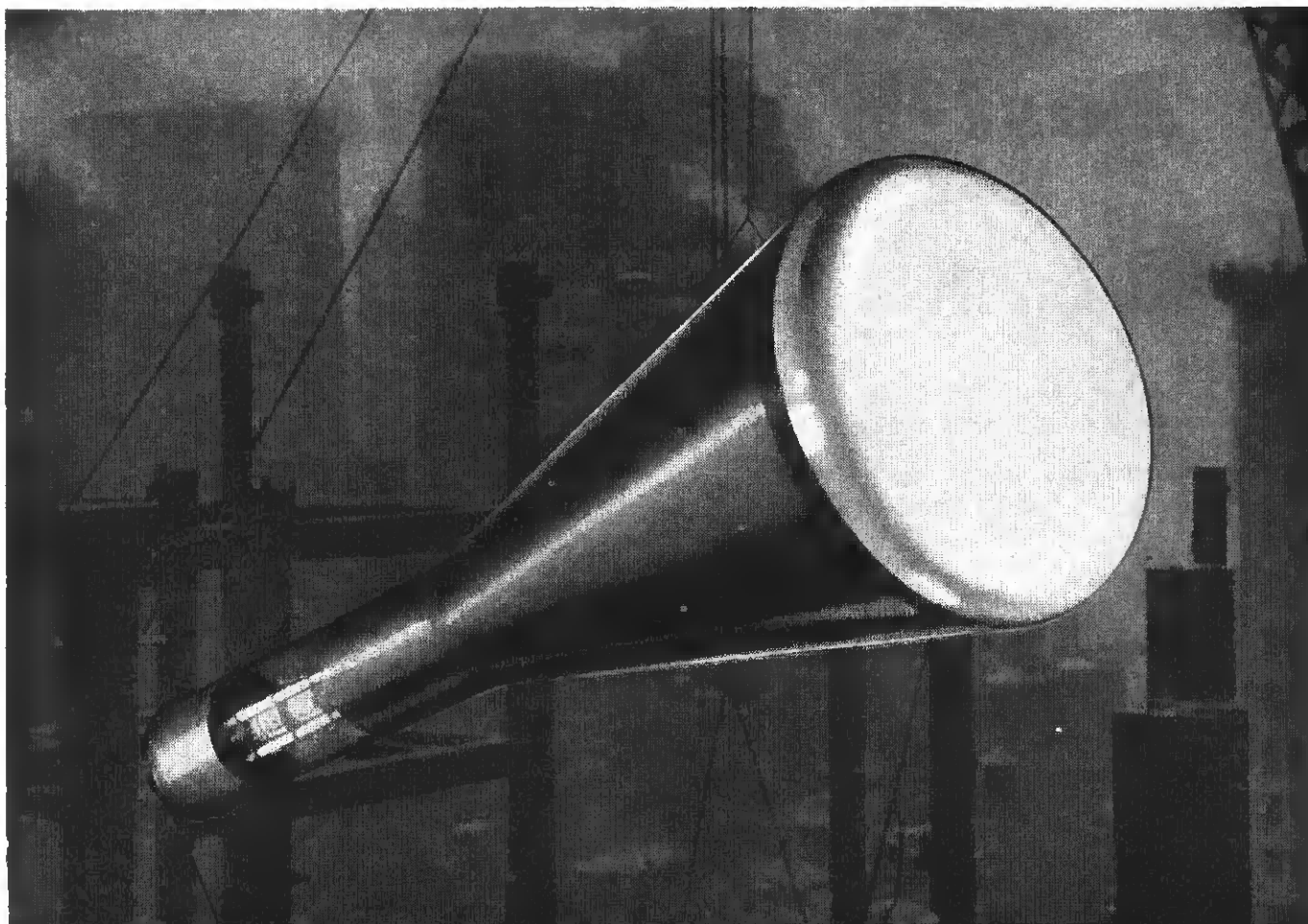

## QUAKE-PROOF CONSTRUCTION



In a few cubic inches of space National Union tube designers plan and build their electronic skyscrapers. Many fragile parts of these intricate mechanisms are precisely balanced, buttressed and welded fast.

For N. U. engineers well know the *rough sailing* that's ahead for these tubes—the shocks, concussion, vibration—relatively far more shattering than the impact of an earthquake on a modern steel and masonry building. So their war job is to build tubes which will stand up and take what comes—whose parts will *stay* in precise alignment—whose exact

clearances will not be altered—whose air seal will not be broken.

To master this complicated construction problem calls for precision engineering of the first order—and a minute knowledge of the strength, rigidity and other characteristics of many metals. The point is—modern electronic tubes are scientific instruments. For post-war tubes of highest character, teamed-up with service assistance to match, service engineers can *count on* National Union.

NATIONAL UNION RADIO CORPORATION, NEWARK, N. J.  
Factories: Newark and Maplewood, N.J., Lansdale and Robesonia, Pa.



# NATIONAL UNION RADIO AND ELECTRONIC TUBES

Transmitting, Cathode Ray, Receiving, Special Purpose Tubes • Condensers • Volume Controls • Photo Electric Cells • Panel Lamps • Flashlight Bulbs

# Post-War Retailing

**Two Sets of Views. Dr. Nystrom on Dealers' Planning. NAB Committee Outlines Dangers Ahead**

• An expert's opinion is that our postwar annual retail trade will amount to at least 75 billions. In an article in the American National Retail Journals Association Bulletin, Dr. Paul H. Nystrom, president Limited Price Variety Assn., and Professor of Marketing at Columbia University, lists a number of things retailers can do now in the way of postwar planning.

Some of Dr. Nystrom's suggestions follow: Estimate the probable effect of the end of the war on your sales. Consider what can be done to maintain or increase your sales . . . Determine what effect the end of the war will have on your store location and plan accordingly . . . Consider requirements for your store property, need for rebuilding, need for new layouts and fixtures . . . Make arrangements for capital. Hold on to reserves. Save now. Pay up debts. Discuss possibilities for obtaining long term loans, as well as commercial credit, with banks and financial institutions.

Dr. Nystrom stresses the necessity for planning to increase your busi-

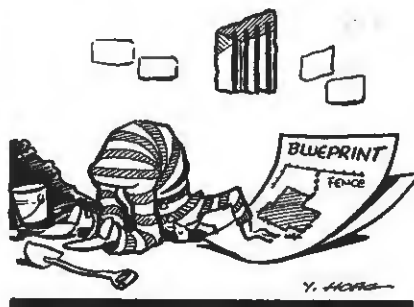

**Make a plan and stick to it!**

ness by holding present customers and obtaining new ones, and urges considering the possibility of handling many goods in postwar period made of entirely new materials, but serving the old purposes.

"Don't hesitate about taking on new goods," points out this well-known economist. "Your problem is not only to maintain employment, but to increase your business. This cannot be done merely by doing the same things in the same way as in the past.

"Plan not only for your interest, but also in the interest of the public welfare. There will and should be competition, but there should also be creative merchandising, the develop-

ment of new consumer demands to the extension of business beyond usual lines. Get the help of your employees by telling them of your plans for the postwar period."

Retailers are also urged to be ready with alternatives to meet changes whenever they occur, and to urge their trade associations to carry on general studies and to provide exchanges of information among members on postwar planning.

In view of predictions by Dr. Nystrom and others that retail business is in for an unprecedented boom, it is interesting to examine predictions on postwar selling techniques and trends as well.

## **NAB Cites "Threats"**

Retailers all over the country have been seeing movies and hearing talks prepared by the National Association of Broadcasters' Retail Promotion Committee, with headquarters in New York. Four possible "threats" to postwar retailing have been outlined:

1. "Factory Outlets. This trend was growing rapidly before the war. In the . . . appliance field . . . it was particularly evident.

2. "Consumer Cooperatives. The . . . expansion of cooperative purchasing of farm supplies is probably the outstanding current trend . . ."

3. This "threat" is described as government participation in the retail picture if "distribution cost crept . . . seriously out of line . . ."

4. "New types of distribution" described "self-service" angle, and the possibility that the idea may spread—that new . . . merchandise dispensers will be created, and a new type of store spring up, built around this idea." Other retailing trends mentioned were super-market type of store, mail-order and chains and the following possibility was suggested:

"Instead of consulting an architect and builder, the home buyer of the future will go to the *home dealer*, just as we used to go to an automobile dealer if we wanted a car. . . ."

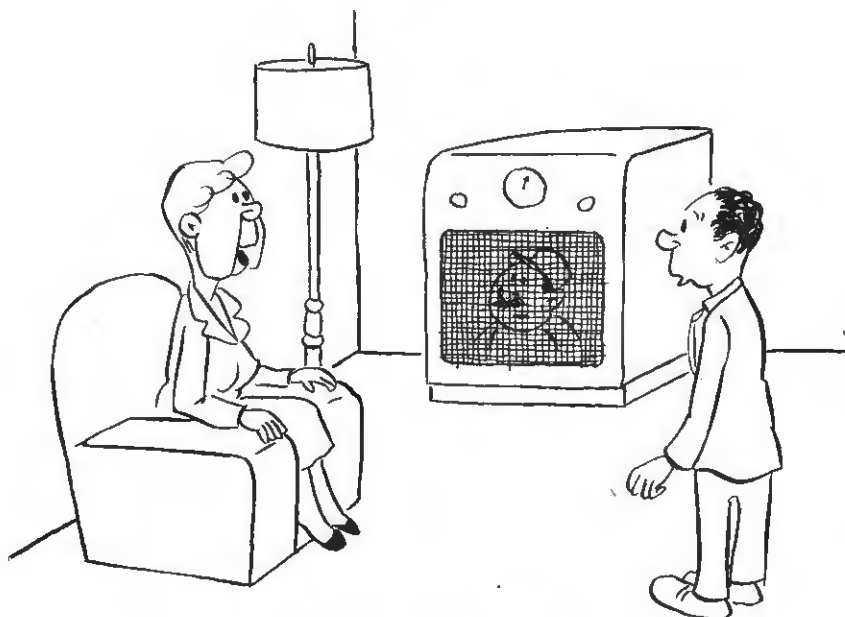

**"That's not television, it's the radio repair man!"**



'ERE NOW! WHAT'S COMIN' OFF?

**(Farnsworth television in England 10 years ago!)**

LONDON's famed Crystal Palace was the scene, in 1934,\* of the first foreign demonstration of the sensational Farnsworth electronic system of television.

In the years since, electronic television has been brought to an advanced state of technical excellence. It is assured a place as a huge post-war industry . . . and right in your field.

*For tomorrow's television dealers will come from the ranks of today's radio retailers.*

Right now, although our entire production is for war, Farnsworth is preparing your huge future market. Our advertising is directed to your customers, explaining the wonders of television, making people want television sets. For, after Victory is won, home television will come, close on the heels of television equipment for countless commercial, industrial and institutional jobs. And post-war Farnsworth television will have the benefit of

our unusual wartime experience.

Farnsworth research for 18 years has pioneered the technical developments of this new art. And Farnsworth research will be of invaluable help to you in the coming age of television.

*\*Another of a series of advertisements depicting milestones in television's history.*

Look for the Farnsworth Television advertising in: November 27 *Collier's*, and November 15 and December 13 *Newsweek*.

**FARNSWORTH TELEVISION**



- Farnsworth Television & Radio Corporation, Fort Wayne 1, Indiana. Farnsworth Radio and Television Transmitters and Receivers; Aircraft Radio Equipment; the Farnsworth Dissector Tube; the Capehart, the Capehart-Panamuse; the Farnsworth Phonograph-Radio.

# All By Himself

• A record department helps Charles Petra, owner of Portage Radio Service, Portage, Wis., stay on the profit side of the ledger. This department, together with a flood of radio service work, gives Petra plenty to do, for he operates this shop all by himself, due to the difficulty of getting trained help.

"While we can't get all of the records we want, we still are able to make quite a few sales on the stock that we have," says Petra. "This is a music loving town and the record department went well from the day I installed it. I couldn't live on record sales alone, but it helps plenty to offset operating expenses."

Portage is a historic town of 7,180 population. It was the home of the late Zona Gale, famous novelist and has many literary and musical clubs. People of all classes want records and have a wide variety of tastes. This is better, Petra says, than if folks all wanted the same type of record.

Petra has been in the radio sales and service field for the past 15 years. His shop is always loaded with radio repair jobs during wartime, and he works long hours to get all the jobs done. So far his tube stock has held out, and he has been able to keep all radios operating that have been brought in. However, he says he



Here's Charles Petra, who keeps 'em playing in Portage. Alone, in busy store, he moved shop up front to save steps and to let customers see how busy he is.

hopes the tube situation will improve shortly, otherwise he will begin to get a little worried.

A sign on his work bench, located right near the front of the store, says "Minimum Service Charge \$1.00." This tells customers they cannot expect any free service, and that during wartime it is worth \$1.00 to work on any set, no matter how small the repair may be.

"Nobody complains about this charge," says Petra. "They all want their radios repaired and will pay almost any price. We have people living in surrounding small towns 10 to 25 miles distant who bring their radios to us to be repaired. It seems that some of the radio repair men in small towns who did such service work on a part time basis have gone out of business, or taken defense jobs, or gone into the army, and this

leaves such towns without service. These folks do not kick at all when they have to bring in their own sets and call for them."

While Petra will repair whatever comes into his shop in the way of small appliances and refrigerators, he sticks pretty closely to radios, preferring to let the heavier appliances go elsewhere. He moved his service bench up near the front of the store so that he wouldn't have to walk so far when waiting on record customers. Then, too, when radio repair customers come in and see him working on other sets they are not so likely to be too insistent that he repair their sets immediately, for they can see that others are ahead of them.

Petra typifies the typical energetic, enterprising radio sales and service man who likes his business.

Below, left, shows Portage entrance, and at lower right, repaired radios and appliances.





# Will They Remember "Rola"?

**S**OME day . . . may it not be far distant . . . huge numbers of our military forces will be returning to Civilian life. When this happens and when these men again become "consumers", will they remember the names of any of the manufacturers who made their equipment, and will they think well of the manufacturer whose product "stood up", even under the toughest kind of usage?

We believe that they will, and, specifically, that the men who depended on Rola headsets and transformers and coils for their Communications in the Air, have acquired a confidence in the name

that will carry over to the new things Rola will be making after the war.

For that reason, if for no other, there can be no compromise with Quality in the Rola products of Tomorrow . . . no matter what they may be. **THE ROLA COMPANY, Inc.**, 2530 Superior Avenue, Cleveland 14 Ohio.

*If what you are making for the War involves Headsets, Transformers, Coils and similar equipment, we believe you should know about Rola's facilities for research, development and manufacture. A representative will gladly call.*

# ★ ROLA ★

**MAKERS OF THE FINEST IN SOUND REPRODUCING AND ELECTRONIC EQUIPMENT**

**Out of  
Majestic's Post-War  
Planning Conference  
has come**

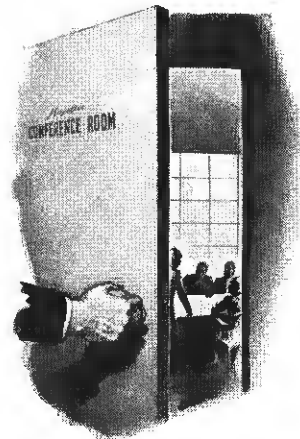

# Majestic's

## PROTECTED-PROFITS PROGRAM

● Majestic's Post-War Planning Conference has been going on now for several months. The end is not yet in sight. Probably there never will be an end, for radio is not a static industry. There will *always* be new developments in every important phase of the industry's activity—and Majestic proposes either to keep abreast or to *set the pace*, in all of them.

But our present planning is not all in the future. Important decisions to guide Majestic's post-war course have already been reached.

Majestic in its post-war planning is determined to avoid, insofar as is humanly possible, the industry's costly errors and pitfalls of the past. To that end, Majestic has adopted as a determined policy the

Majestic PROTECTED-PROFITS PROGRAM.

Majestic will give greatest care and attention to the development of each phase of this program, as explained on the opposite page. The key to all post-war Majestic thinking is in the word, CONTROL. The program itself, each component part of its operation, must be so *controlled* as to produce the greatest degree of post-war prosperity for all Majestic Distributors and Dealers.

You will wish to give this program your most serious consideration. If you have comments feel free to express them to us *now*. The Majestic Post-War Planning Conference is *still* going on. We *can* and *will* make room for sound ideas that will benefit the industry, the trade, and hence The American Way of Living we are all striving to defend.

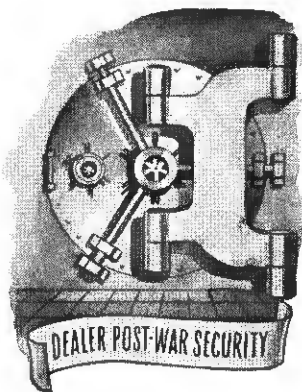

**Majestic**

**MIGHTY MONARCH OF THE AIR**

*In Wartime As In Peacetime*

RADIO Retailing TODAY • December, 1943

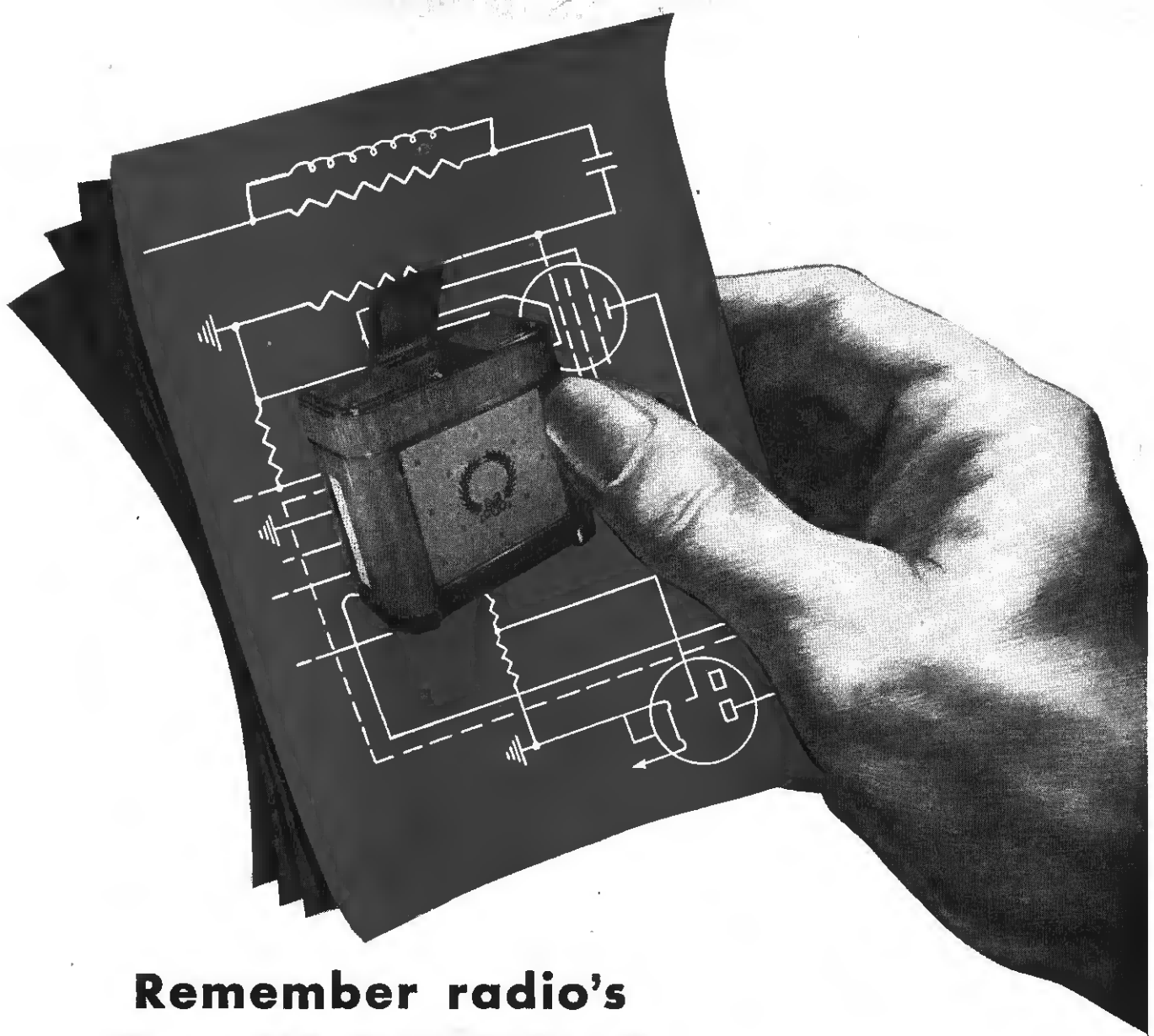

## Remember radio's first FM RECEIVER?

**Another General Electric "first" that made radio history... and, after the war, General Electric's unequalled experience will bring you an even greater FM home radio to sell!**

Yes, it was General Electric that first introduced FM (Frequency Modulation) receivers — back in 1939.

Today, thousands thrill to this revolutionary new kind of radio reception — lifelike "natural color" music — with all the *overtones* you miss in conventional radio.

In a recent study, based on 635 personal interviews with radio owners, *85 per cent* said they preferred FM to regular broadcast reception — and *91 per cent* said they would recommend FM to their friends!

Since FM was introduced, General Electric has each year produced a finer product at a lower price. After

the war, the G-E FM receiver will be even better and will offer a still greater value.

Make no mistake about it! You'll have a big seller — after the war — when General Electric — *with more experience with FM than any other home-radio manufacturer* — brings you a great new line of home radios! Wait 'til you see what this line will do for you! *General Electric, Bridgeport, Connecticut.*

• Tune in "THE WORLD TODAY" for news direct from the men who see it happen, every evening except Sunday at 6:45 E.W.T. over CBS. On Sunday listen to the G-E "All Girl Orchestra" at 10 P.M. E.W.T. over NBC.

GENERAL ELECTRIC IS BUILDING MORE MILITARY RADIO EQUIPMENT THAN ANY OTHER HOME-RADIO MANUFACTURER

**GENERAL  ELECTRIC**  
175-812

FIRST IN RADIO, TELEVISION, ELECTRONICS



# FATHER AND SON

*Radio Electronic Maintenance Men and Merchandisers as Well*

• When you walk into the Bricker Radio Service Shop the place just spells Enterprise! Sets are in process of repair—lickety-split! More sets are moving in to pause in line for their turns. Action with speed and precision is the keynote. Accomplishment is in the air—and one feels, too, that plans for the future are simply buzzing around work now being done.

The Brickers, Paul and Kenneth, are father and son. "Like father, like son"—one catches from both that drive and persistence with which they have done a whopping good radio sales and service business in the past—right through these difficult times. And they are looking to the future!

In the radio business for 18 years, this lively team bought well in tubes and parts in 1941. Their current stock is amazing (see front cover) and is their radio life-line.

Relentless in their search for new stock, they are still alert to locate replacements. Constantly on the lookout to buy up inventories of retailers who are folding, they travel extensively, and continuously, to find needed parts. They "bring the mountain to Mohammed" which in this case is Main Street, Mansfield, Ohio.

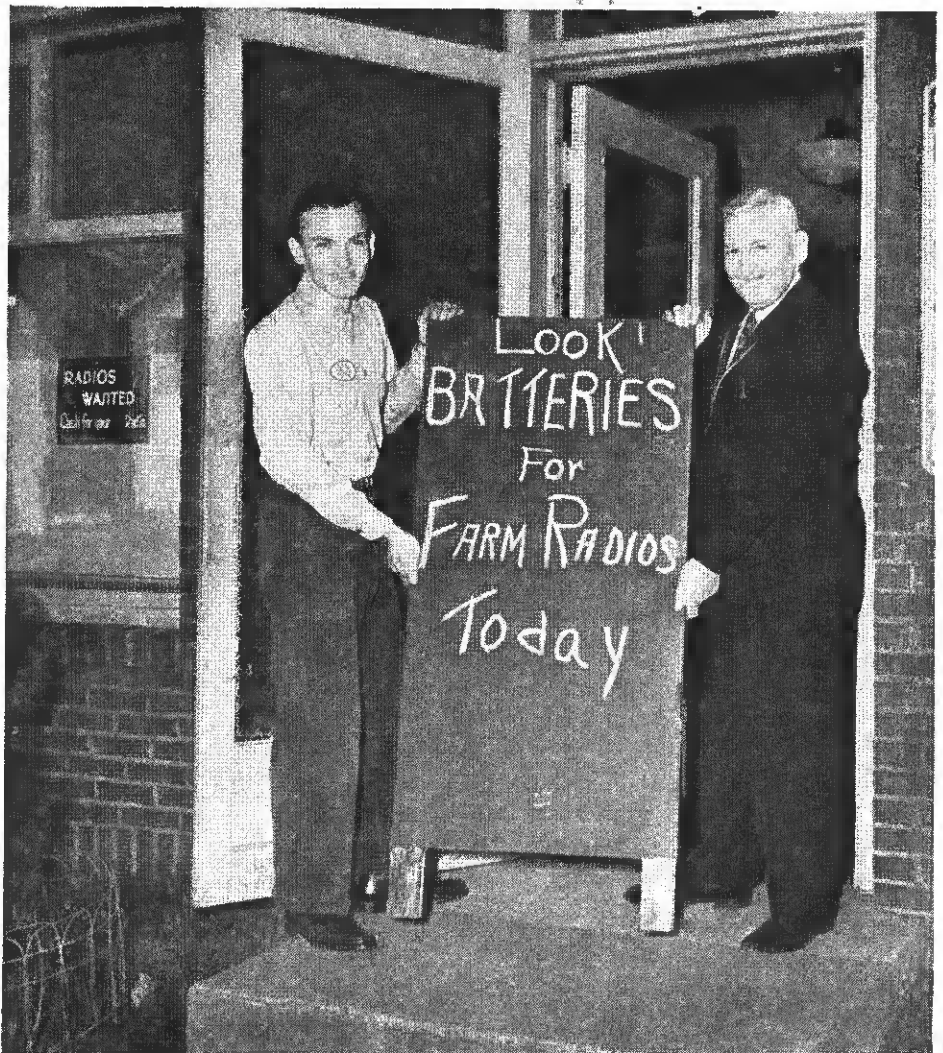



← Kenneth Bricker shows his wife voltage checking technique. Note visibility of test equipment on sloping panel.

Their store interior is in top notch order. All space is economically used, and arranged for the most practical running of their business. The opening front door rings a bell in the service department, which is partitioned off from the store section.

The store portion has the larger sets waiting repair neatly aligned along one side, leaving plenty of space for customers and incoming sets between door and counter. Behind the counter, tubes and parts are shelved in good order and look bright and clean. All of the business-like appearance of the Bricker Radio Service Shop is indicative of the type of radio maintenance work done here.

## TEAM

In the Bricker Service Shop, the actual space devoted to repairing sets is laid out for maximum efficiency. Tools and equipment where you can find them, and complete freedom from odd lengths of clipped wire, solder drops, etc., make possible speedy service jobs.

The broad work bench is covered with a felt material kept free of metal scraps by a vacuum cleaner. This practice saves time in the long run since one small drop of solder falling into an IF can will consume plenty of time in getting it out.

Tools, extension cords, test leads, needed tubes and parts, are kept in racks where they are instantly visible. Tools you can't find don't make any money.

The work bench panel, sloped for visibility, is neat and arranged for efficiency. Technical literature is conveniently stored on the shelf above the bench. Behind the bench, flanking the entrance to the workshop are two handy corners—one equipped

← Kenneth and his father, Paul Bricker, taking the portable sign out to let their customers know that farm batteries are in stock. → Young Bricker shows how time can be saved when tools and parts are arranged for easy finding. For glimpse of the Brickers' tube stock see front cover.

with writing bench and stool where the billing is done and accounts kept, the other (see photo below) where tools and special equipment of the smaller order are stocked. The service department is distinct and apart from the sales operation.

"It requires a great deal of patience and concentration to locate trouble on the hard-to-fix radios of today," explains Mr. Bricker, "so our workmen do not seek to entertain the public. However, we have the latest and best test equipment we can get and keep the shop neat and orderly, and welcome visitors who have a genuine interest in seeing how the work is done.

"Before the war we concentrated on selling new and used home and auto radios. We handled all the used or 'trade-in' sets from two of the

largest department stores in a nearby city, and ran a continuous ad for used radios in the local paper. Handling such a volume, we took small profit and sold without guarantee or home demonstrations, except in unusual cases. For the past year we have bought a few small sets needing a tube or minor repair, reselling most of these for use by soldiers in camps.

"Foreseeing what the war might bring we stocked radio tubes and parts and up to now we have had no serious shortages. Although the repair business has greatly increased, we are still trying to give twenty-four hour service. **WE DO SHOP WORK ONLY, AND EVERYTHING IS CASH!**

"We have done some circuit chang-

*(Continued on page 54)*

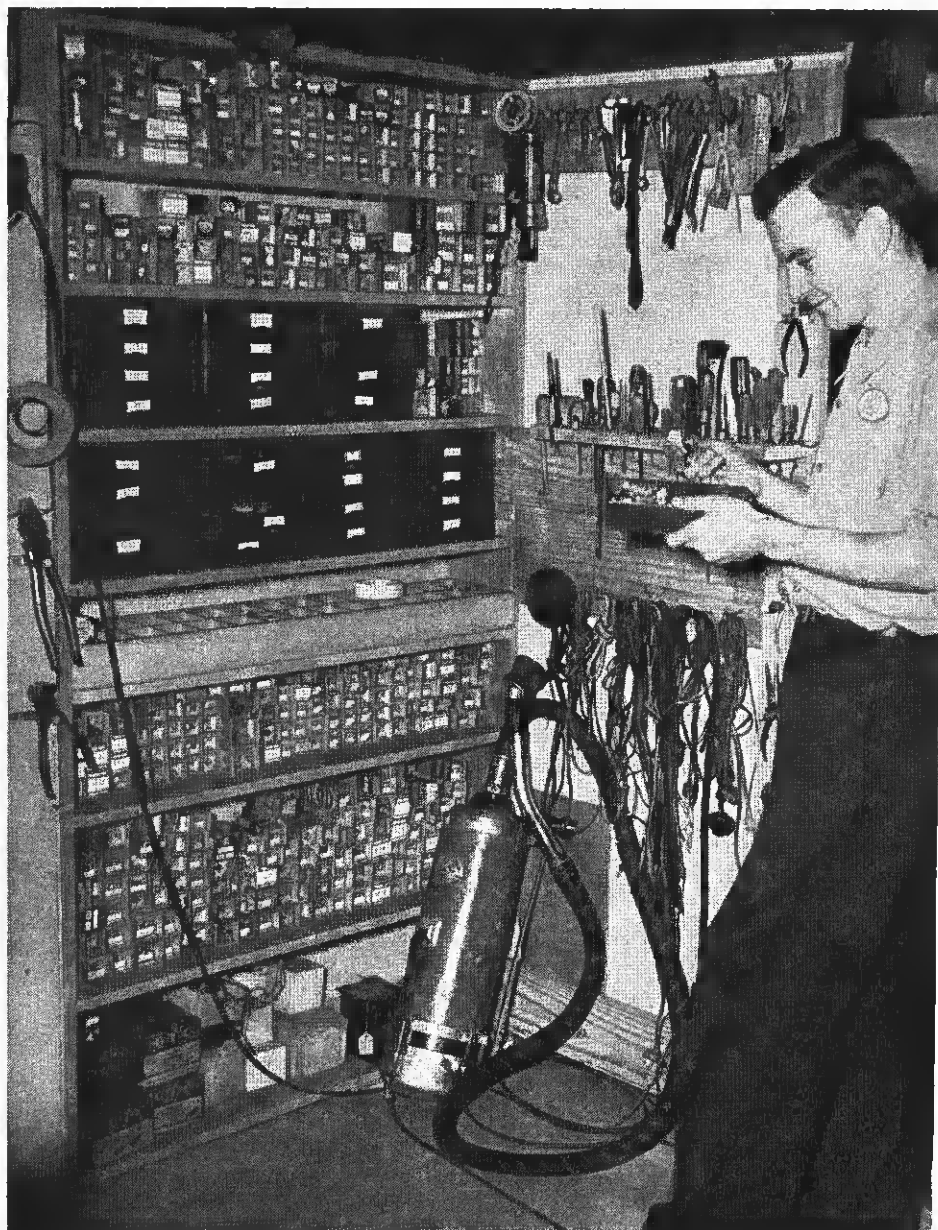

# ELECTRONIC MAINTENANCE TODAY

★ RADIO, TELEVISION AND INDUSTRIAL SERVICE ★

## New Circuit Changes

*More interchangeable tube circuits  
for hard to get types*

As the types of tubes available for use in replacement, become more scarce substitutes for substitutes are necessary. Versatility is the only solution to many a tough problem.

Further notes on these important circuit changes, as supplied by servicer M. G. Goldberg of St. Paul, Minn., will prove to be of value in solving some of the shortage headaches.

The notorious shortage of 12SA7 and 6SA7 tubes was offset by the use of 12K8 and 6K8 types (see July issue of RADIO RETAILING TODAY), but now some localities have used all these available tubes. Another possible solution is the 12SK7 and 12SJ7 pentodes. While these tubes are not intended to function as converters, they can serve. The gain of the converter stage with this substitution is materially reduced and performance will not be as good as previously. The set will still perform adequately for local station reception.

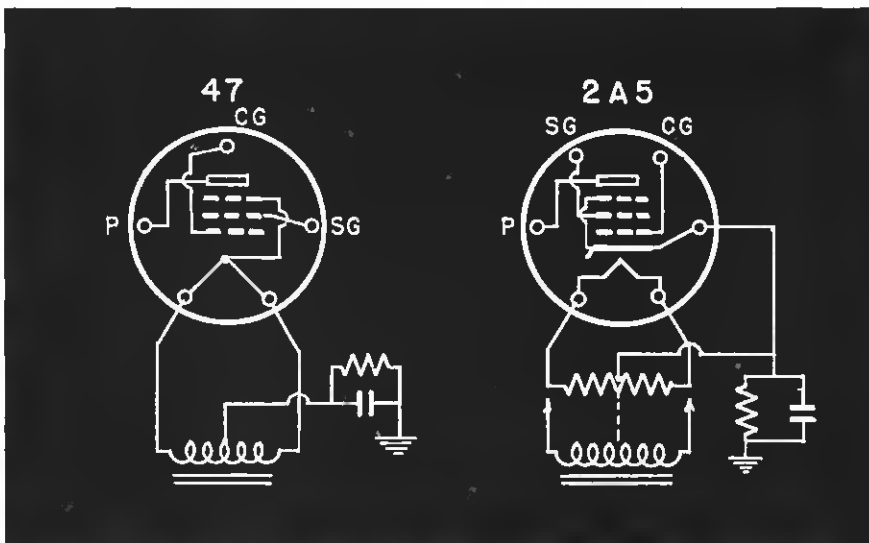

Fig. 2—Shortages in 47 types can be offset by use of 2A5 as shown. Similar current and bias requirements make it unnecessary to change bias resistor.

Fig. 1—Socket wiring changes to replace 12SA7 with 12SJ7 or 12SK7. The change reduces sensitivity but set will function for local station reception.



### 12SA7 Notes

The changes in the socket wiring are simple and few. In Fig. 1 the five necessary changes in the wiring are shown. The changes are as follows: (1) Interchange the wires to lugs 3 and 8; (2) Temporarily lift all leads from lug 6; (3) Move all leads from 4 to 6; (4) Move wires from 5 to 4; (5) Solder remaining free leads to 5; (6) Realign all circuits carefully.

It will be noted that in this new converter circuit, the screen of the SK7 or SJ7 tube serves as the oscillator anode. The suppressor grid of the substitute tube becomes the control grid of the converter section.

If the set is not sensitive enough with the new substitute, it may be necessary to use extra antenna. There is little choice between the SK7 and SJ7 types since the variable mu fea-

### 25Z5-25Z6 Change

In the rectifier group, there is a useful interchange between 25Z5 and 25Z6. Either can be exchanged for the other by changing the socket and making the wiring shifts shown in Fig. 4. These tubes have identical characteristics.

### Interchangeable Rectifiers

Rectifiers in general are coming through either very slow or in the case of some types not at all. In table models with low current drain, the 5Y3, 5Z4 and 5W4 may be interchanged directly. The characteristics are similar and little or no change in performance will be found. In small consoles, the 5Y3, the 5Z4 and the 5V4G may be directly interchanged. In large consoles, the 5U4G and 5T4

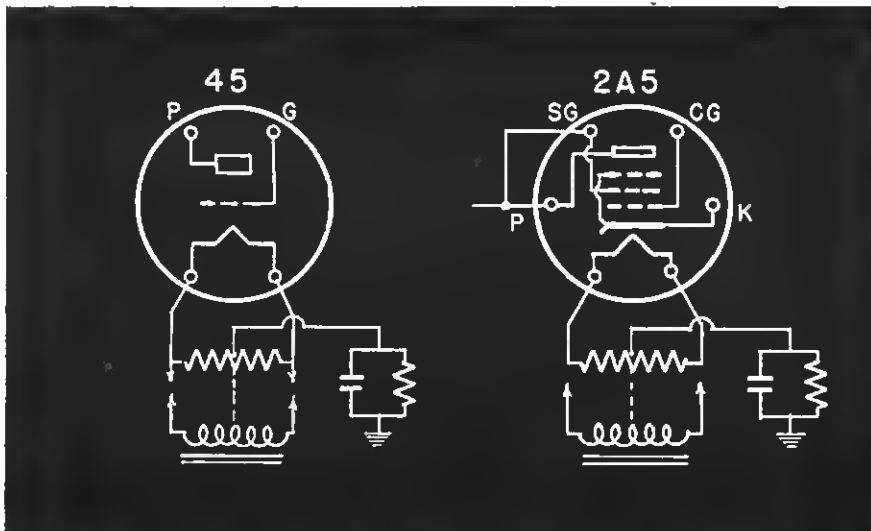

Fig. 3—The 45 can be replaced with a 2A5 by changing socket and bias resistor to 400-450 ohms. Cathode of 2A5 should be tied to C.T. of filament circuit.

ture of the former has little bearing on the performance. The same system is of course applicable to the 6SA7-6SJ7-6SK7 switch.

### Handling 45 and 47 Tubes

The revitalizing of old sets has brought a shortage in the 45 and 47 power tubes. The 2A5 pentode can be used to replace both of these scarce types. In Fig. 2 and Fig. 3 the necessary circuit changes are given. Since the 2A5 is a 6-prong tube, a socket change is necessary. The cathode lead for the 2A5 should be connected to the center tap of the filament circuit. The bias requirements for the 47 and the 2A5 are about the same as are the current totals so that little or no change is required in the self-bias resistor if this is used. When replacing the 45 tube, the screen of the 2A5 is tied to the plate. Here also, the cathode should be connected to the center tap of the filament circuit. The bias re-

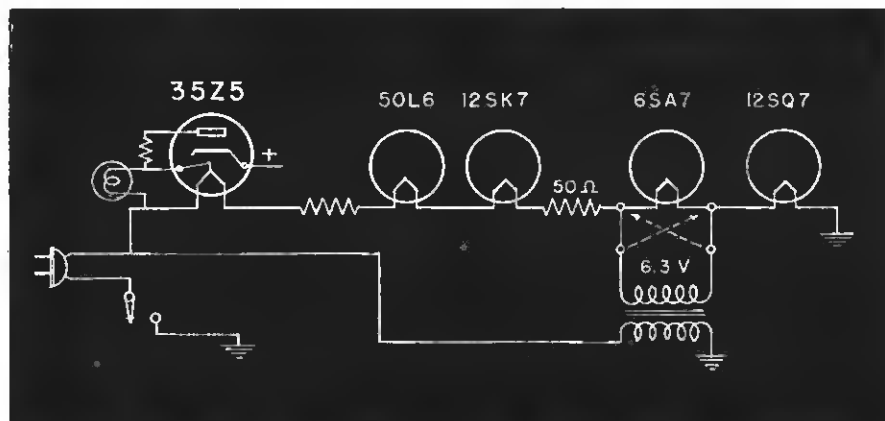

Fig. 5—A missing series filament tube can be replaced with low voltage type and filament transformer. Reverse secondary leads for dim operation of pilot bulb.

quirement for the 2A5 is only about one-half that of the 45 so that the self-bias resistor should have about one-half of its former value or if another bias system is used, appropriate changes made.

may be interchanged. The 5Y3 and the 5Y4G tubes may be interchanged if one heater lead is moved on the socket and the two plate leads.

### 12.6 and 6.3 Volt Tubes

In the July issue of RADIO RETAILING TODAY was shown a method of using a 6.3-volt transformer and 6.3-volt tubes to replace those higher voltage tubes not obtainable. A more general case of using this transformer to replace individual tubes is shown in Fig. 5. For example, a 12SA7 may be replaced with a 6SA7 by supplying the filament voltage of the new tube from a separate transformer. Add a 50-ohm 2-watt resistor to the string to make up for the extra filament drop. Connect the secondary of the filament transfer so that the pilot bulb dims. Try reversing leads to get this condition. Any 12-volt tube may be replaced by this method but if two or more tubes must be changed, the method shown in RADIO RETAILING TODAY for July is best.

Fig. 4—These rectifier types can be interchanged by using octal socket for 25Z6 and 6 prong for 25Z5. The electrical characteristics are identical.

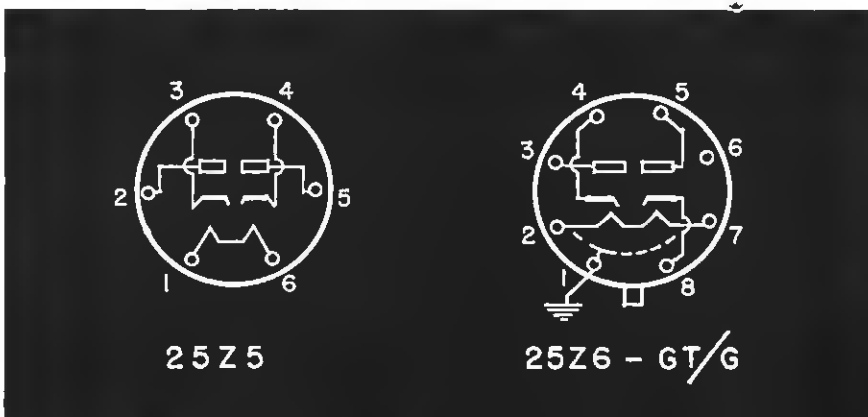

# NEW PRODUCTS

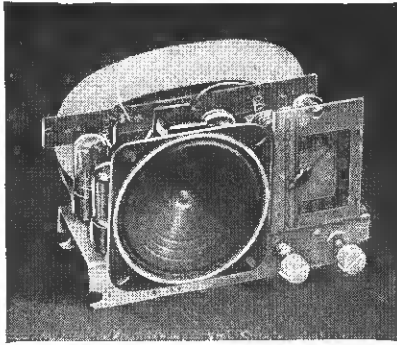

**RADIO RECEIVER KIT** now available to schools and colleges conducting war training programs. Five-tube kit permits study of basic receiver subjects such as rectification, filtering, detection, RF, IF and AM amplifications, etc. The kit consists of all necessary parts, wire, hardware, solder, tubes and speaker. Chassis is formed, punched and rust-proofed. The only tools needed for assembly are screwdriver, pliers and soldering iron. Allied Radio Corp., 833 W. Jackson Blvd., Chicago 7, Ill.—RRT

**SNAP-ACTION RELAY** is designed for electronic circuit applications calling for sensitive unit having snap-action

contacts. Contact pressure of this relay remains constant despite slow variations in the coil current. When the coil current reaches a certain point, the contacts operate with a positive snap action. Operates on as little as 10 milliwatts in its coil circuit. Struthers-Dunn, Inc., 1321 Arch St., Philadelphia, Pa.—RRT

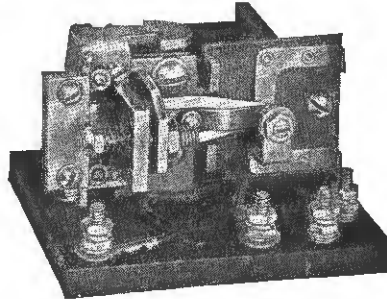

**SIGNALLING TIMER** sounds alarm → and the pilot light goes out when the interval is completed. Buzzer continues to sound until the toggle switch on timer is snapped off or the timing interval is again started. The moving pointer revolves counter-clockwise toward zero; at any second during the interval the exact time elapsed is shown on the dial. Socket on side of timer case provides for connection of additional lights or alarms. Size 5 x 5 x 3½

in., 115 to 230 volts; 25, 50 or 60 cycles, 1000 W. capacity, available in 8 models with time intervals of 1 minute to 3 hours. Industrial Timer Corp., 117 Edison Place, Newark, N. J.—RRT

**COILS FOR ELECTRONIC HEATING** applications up to 1 kw. "Air-Wound" design (no solid winding form). Coils are light in weight, adaptable to numerous mounting arrangements, sturdy, low dielectric loss. Are wound to uniform pitch. Barker & Williamson, 235 Fairfield Ave., Upper Darby, Pa.—RRT

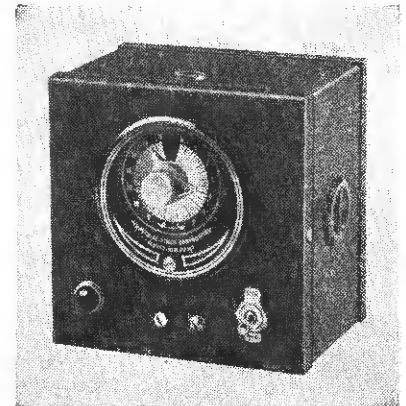

## Father & Son Team

(Continued from page 51)

ing, mostly for experiment as it might be necessary later on. Voltage checking is the simplest service routine but we find it also necessary to use different methods. Following are two helpful 'tricks' we use with success: To eliminate the come-back of many small AC-DC sets we drop the voltage slightly. A successful short-cut in determining burned-out tubes in AC-DC sets without removing them is a neon bulb across the filament prongs of each tube. If the tube filament is open the bulb lights. At the same time, the neon bulb will determine whether line voltage is entering set, thus checking whether the line cord or switch is broken. We have found that by removing chassis from cabinet and using this test, much time is saved in small AC-DC set check-ups.

"Many people now willingly bring

in their radios for repair, knowing the war is the reason for many changes. If after the war the people want to go back to the old ways and our competitors again 'offer the moon,' we will too, by putting a service truck on the street, we'll build on an inside auto drive-in shop and be satisfied with small profit and volume selling again."

### Reconditioning Sets

Bricker Radio does an excellent business in reconditioned set sales. Journeying to surrounding big cities, they make a specialty of buying *slightly used* expensive sets—as high as the \$1200 bracket—which are purely white elephants to the retailer in the large city—for a song. Reconditioned, these sets sell for a good price and are much-to-be desired merchandise. Last year they sold eight truck-loads of these radios. Profits were good, and there are no grumbles from the purchasers. Reason—the Brickers do an excellent rebuilding job. Spot ads in local paper are used

when necessary.

Bricker Radio's golden rule in this respect is never to accept an imperfect part from a jobber. Champions of their jobber as a necessary asset to the radio dealer, these men have refused much needed tubes at a slightly higher price from "unknown" suppliers. They test all parts upon receipt from the distributor to be sure they are perfect. Any weak members of the lot are returned to the jobber—and never passed along to the customer in a repaired set. In this way, everyone in the transaction is treated fairly, and a good job of work is done.

"Our only guarantee is fair dealing and specific time guarantee on the parts we replace. By consistent use of standard high grade parts we have little trouble here," say the Brickers.

Further evidence of the Bricker's enterprise and proof of their profits is that they plan to expand their quarters right now—just as soon as material and labor for the job are available.

# THIS PRECISION DEVICE

## IS "MASS PRODUCED"

### BY MAGNAVOX

*Magneto-Dynamic Speaker  
for military headphones—  
a "miniature loud speaker."*

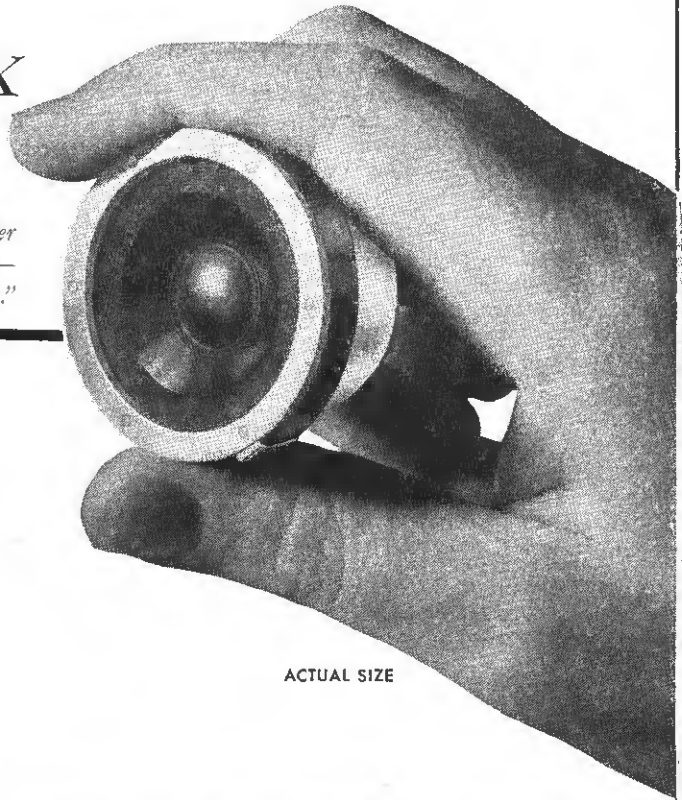

ACTUAL SIZE

THERE'S QUITE a contrast in size between this tiny speaker and a conventional 15-inch radio speaker. Yet Magnavox makes both—along with numerous other items of military equipment, ranging from solenoids to the most intricate types of complete radio communication systems.

A very high degree of precision is required to get maximum efficiency in so small a space. Though this device is made with almost "jeweler's" precision... containing windings finer than a human hair... it is turned out by mass production methods through the skill of Magnavox engineers.

Magnavox brings to the war effort the skill and "know how" developed by 32 years of designing, engineering and manufacturing for the radio industry, plus the splendid facilities of the completely

modern new six-acre plant, finest machine tool equipment and the production economies of efficient management. The Magnavox Company, Fort Wayne 4, Ind.



Magnavox skill and craftsmanship won the Navy "E" in 1941, among the first awarded... now with 3 White Star Renewal Citations.

FOR 32 YEARS **Magnavox** HAS SERVED THE RADIO INDUSTRY

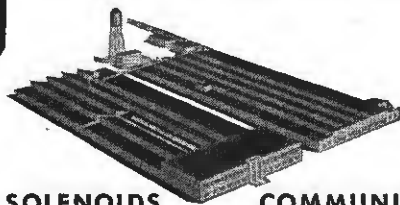

LOUD SPEAKERS • CAPACITORS • SOLENOIDS

COMMUNICATION & ELECTRONIC EQUIPMENT

RADIO Retailing TODAY • December, 1943

55

# BOOKLETS IN REVIEW

A new booklet by RCA Mfg. Co., Camden, N. J., describes Practical Radio Experiments and Demonstrations with The RCA Dynamic Demonstrator—a receiver with parts and circuit mounted for testing and display. Price 25c. R.R.T.

A consolidated service manual for all Philco refrigerators through 1942 includes service instructions, parts list and special repair techniques. Philco Radio and Television Corp., Parts and Service Division, Philadelphia, Pa. R.R.T.

Victory Line Capacitors is title of new folder from Sprague Products Co., North Adams, Mass. Along with types and ratings, useful information on replacing wet and high voltage paper units is given. R.R.T.

Sound systems for fixed and mobile installations, inter-communicators, master school and factory systems, and complete line of accessories are shown in new catalog available from Bell Sound Systems, Inc., 1193 Essex Avenue, Columbus, Ohio. R.R.T.

New Sherman Paper Products Display Guide gives clever suggestions on year 'round window displays and in-

## THE RADIO INDUSTRY IN WARTIME—ITS MAGNITUDE DECEMBER 1, 1943

Compiled by "Radio Retailing Today"

	Total Investment	Annual Gross Revenue	Number of Employes	Annual Payroll
Radio manufacturers (1200) .....	\$350,000,000	\$3,500,000,000	350,000	\$800,000,000
Radio distributors, dealers, etc. ....	280,000,000	200,000,000	100,000	150,000,000
Broadcasting stations (947) .....	90,000,000	215,000,000	*20,000	55,000,000
Commercial communication stations .....	60,000,000	—	15,000	7,000,000
Listeners' sets (57,000,000) .....	3,600,000,000	—	—	†320,000,000

\*Regular staff—not including part-time employes, artists, etc., who number at least 25,000 more, and earn in talent fees \$45,000,000.

†Annual operating expense for listeners' sets, for tube replacements, electricity, servicing, etc.

terior decorations. Complete line of background, pedestal, trim and other display material shown. Copies available free. Sherman Paper Products, Newton Upper Falls, Mass. R.R.T.

### Finds Charts Informative and Up to the Minute

Editor, *Radio Retailing Today*:

My compliments to you and to your consulting engineer, Ralph R. Batcher, on his wonderful charts in your late issues. I have bought many books on radio, etc. but nothing in them ever came close to these charts for real information. Most books describe old outmoded equipment or just carry fundamentals out to six places, or put them into logs, and calculus.

The electron-tube chart is up to the minute and even a couple of years ahead. I did not expect to see such circuits as Nos. 48 through 53 until after the war, at least.

If Mr. Batcher ever writes a book, I want one. Sometime I hope he will get out a book that is full of real information. Some of the books one pays \$6 or \$7 for, carry an impressive engineering or electronic title, but are not worth the paper cost.

Incidentally, your "Radio Retailing Today," though limited in material that can be made available during these times, is still right on the ball.

FRED E. ALLEN

449 Howard Street,  
Brockton, Mass.

## POST-WAR PLANNERS GET THE PICTURE . . . ACT NOW!



Westinghouse Electric Appliance Division's Planning Committee includes three factory executives and six distributor reps. Plan for the future with action now!

Standing left to right: J. H. Ashbaugh, division manager; W. W. Grant, director of marketing research; E. C. Brauning, vice president, American Sales Co., Columbus, O.; and T. J. Newcomb, division sales manager and the committee's chairman. Seated, Henry Czech, Westinghouse Chicago district manager; H. B. Donley, Westinghouse New York City general appliance manager; J. S. Shaw, electrical department manager, Moore-Handley Hardware Co., Birmingham, Ala.; E. B. Ingraham, president, Times-Appliance Co., New York City; T. F. Savage, president, Intermountain Appliance Co., Denver, Colo.

**RCA  
PRESENTS**

# What's New?

*Strange New RCA "Lighthouses" may Send Television  
to far Corners of the Earth*

**NETWORK TELEVISION PROGRAMS REACHING  
WORLD'S REMOTEST CITIES, TOWNS AND  
VILLAGES ENVISIONED BY BEAL**

EVERYBODY knows that radio programs get "relayed" all over the globe. And now comes the news that network television programs may some day travel just as far, just as fast! That's the word from Ralph R. Beal, of the Radio Corporation of America Research Laboratories. A radically new form of *automatic* radio relay station, looking much like a lighthouse, "will make relaying of Television programs a relatively simple matter," says Mr. Beal. "The routes of these radio relays will extend to any part of the world."

This forward-looking concept gives a hint of how Radio Corporation of America research and engineering will help create the vast new television industry that you, the radio dealers of America, will have a part in.



**HOP-SKIP-JUMP**

Acting in concert, the "lighthouse" relay stations will pass television micro-waves along in hop-skip-jump fashion from one country to another and from one continent to the next.

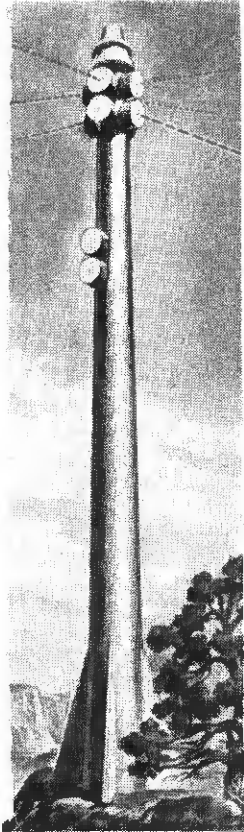

*What's New?*

**IS HELPING TO BUILD A GREAT  
POST-WAR MARKET FOR RCA DEALERS**

• New comedy find is funny man Jack Douglas, shown at right in picture as host Don Ameche, introduced him to "What's New?", heard over the Blue Network, Saturday, 7:00 P.M. to 8:00 P.M., E.W.T. This show is accomplishing the aim of creating a big post-war demand for RCA radio, phonograph and television instruments and is thus laying the ground work for your own profitable post-war business.



*Tonight at 8 - Movies for  
our soldiers in Australia*

• Tonight, in far-off Australia, battle-weary men may be entertained by Hollywood's greatest movie productions, brought by RCA Portable Photophone Units especially designed for this rugged job "down under." This is another example of RCA's outstanding electronic "know-how." After the war, the RCA storehouse of knowledge and experience will be unlocked to produce for you the finest radio, phonograph and television instruments our business has ever seen.



**RADIO CORPORATION OF AMERICA**

RCA VICTOR DIVISION • CAMDEN, NEW JERSEY



# Washington Wavelength

## Bureau of Census Making Nationwide Survey for OCK

A country-wide consumer survey is being conducted for the Office of Civilian Requirements by the Bureau of Census, WPB Chairman Arthur D. Whiteside has announced.

The survey commenced last month. Enumerators are now visiting 7,000 households to ask civilians about the availability of 115 types of goods and services used in the homes and on the farm, including radio, refrigerators, laundry equipment and many other appliances.

The information obtained will be collected and analyzed to find the answers to these questions:

1. To what extent are shortages and other consumer problems causing actual hardship?

2. What products now in short supply are most needed by the civilian population, and is the lack of any specific item so seriously affecting health and morale as to interfere with the productive efficiency of war workers, farmers and other civilians?

3. Is the available supply of consumer goods being distributed fairly?

4. What is the quantity of durable goods such as electric irons and wash-

ing machines now in the hands of consumers and what condition are they in?

The survey is designed as a scientific cross-section of the entire United States.

## "Wire" Regulation Changed

CMP 9, described in detail in the October issue of *Radio Retailing Today*, and describing how retailers could obtain copper wire, has been amended. Changes include a reduction in the amount of copper wire which retailers may obtain from \$100 to \$50 worth per quarter, or one-sixteenth of the amount sold during 1941, and a provision that retailers may fill farmers' orders for copper wire upon receipt of a copper allotment certificate.

## What to Do With Those Discarded Radio Tubes

Some radiomen have been experiencing difficulty in getting rid of dead tubes. Following receipt of a number of requests asking clarification of this subject, *Radio Retailing Today* wrote the War Production Board in Washington, and has received an answer from Glenn G. Henry, chief audio and industrial section, domestic and for-

eign branch of the Radio and Radar Division.

Mr. Henry called attention to Order L-265, and said: "As you are undoubtedly aware, this Order provides for the exchange of a new part for an old part. It is the primary purpose of Paragraph B-4 of L-265 to remove from circulation any stock of defective parts which might otherwise be used over and over again. The original Order provided that such parts must be disposed of through salvage channels. However, this has been modified to also permit such parts to be destroyed where they have no salvage value."

## Restrictions on Recording Discs, Needles, Removed

Through an amendment to Limitation Order L-265, restrictions on the transfer of blank recording discs and cutting styli (recording needles) were recently removed by the WPB.

The discs and styli are used chiefly in connection with radio broadcasting and sound recording, and to a lesser extent by individual consumers for home recording purposes. Commercial users of such discs and styli purchase them normally as operating supplies, the radio and radar division of WPB said. Preference Rating Order P-y33 as amended, gives a priority rating of AA-1 and use of the MRO symbol to persons engaged in the radio broadcasting business and a rating of AA-2 and use of the MRO symbol to commercial sound recording.

It was felt that individual purchasers of discs and styli for home recording purposes should not be subjected to the continuance of the restrictive requirements of preference ratings at the ultimate consumer level. The discs involved are composed principally of chemicals, lacquer and paper.

## Tune-Ins

"I have never been afraid of trouble. I have always had this slogan: 'If somebody hands you a lemon, make lemonade out of it.'"—Homer E. Capehart, president Packard Mfg. Co.

\* \* \*

"The United States Supreme Court recently ruled that 'house-to-house canvassing' and the right to 'ring a doorbell' are part of the rights of freedom of speech guaranteed by the Constitution. Incidentally, they are darned good ways to sell merchandise, if we just had merchandise to sell."—Electrical Appliance Retailer News, Va. Public Service Co.

## BACKING THE ARMED FORCES



Major General W. H. Harrison, left, Officer in Charge of Signal Corps Procurement and Distribution, stops to inspect a cable machine. He is being escorted through the Rochester, N. Y., plant of the Stromberg-Carlson Co. by Dr. Ray H. Manson, vice president and general manager (right).





## PURCHASING TODAY IS FINDING!

Purchasing used to be almost an armchair job, with salesmen camping on our door-step.

But mostly, today, we *go out and find things!* Today we interview twice as many representatives here in Cincinnati as in 1940.

Our Field Buyers are located at important points of the country. Our men are travelling constantly—and bringing back materials.

This Department is six times as big as in 1940. It's divided into sections with four or five specialists in each section.

We send out over 3,000 inquiries a month, about a thousand telegrams every thirty days, and issue 10,000 purchase orders monthly.

Today Purchasing is finding the quality people who can produce quality merchandise at the right price—*fast!*

This is the fourth of a series describing the various departments working together as a team in the Manufacturing division of Crosley. The subject of this advertisement is Purchasing.

# CROSLLEY

THE CROSLLEY CORPORATION - CINCINNATI, OHIO AND RICHMOND, IND.  
Peacetime Manufacturers of Radios, Refrigerators, Household Appliances, and the Crosley Car  
HOME OF WLW, "THE NATION'S STATION"



# Letters to the Editor

## How to Get More Records This Dealer's Problem

Editor, *Radio Retailing Today*:

Your article, "Around the Disc," page 32, October issue, states that dealers are getting records in "sufficient quantities." I don't know what part of the country your writer checked, but certainly not this part, and if a more equitable distribution could be arranged, local dealers would be most grateful.

I was told last week by a member of my family that Nashville, Tenn., windows are full of the current best-sellers. I have had one shipment during October from my distributor. Not one current hit was included. My shipments from the distributor have been more frequent—four during October—three containing current sellers—one to three of each! Sufficient? All dealers here are affected the same way. I do

not handle records, but our store dealer told me that she had received only about one hundred twenty-five records in a six-week period.

Classics come in somewhat better and hold sales up to a certain extent. However, when production has been cut 70 per cent by government order, and surely at least five times as many people are trying to buy, there certainly can't be a "sufficient quantity." I had been reconciled to this condition. But it is definitely not fair for some parts of the country to be so plentifully supplied while others of us are cut to such a small per cent. If the "quantity" is really available to me I can really have a business.

If your writer can discover how to equalize these plentiful stocks with some of the rest of us, we Richmond, Ind., dealers will be very happy.

The same article (many others do also) speaks of radio retailers looking

to records to "fill the gap" caused by lack of radios. Why should record companies take on new dealers when they can't supply those who have spent time and money building up the business? They are doing it, and I suppose that is another reason for the shortage.

If the trade magazines can help with problems of this kind, it would be a worthy cause.

LURA C. WINE

*The Record Shop  
of The Snyder Radio Store,  
Richmond, Ind.*

## Alaska Radio Dealer Could Use "Combinations"

Editor, *Radio Retailing Today*:

In your issue for September, 1943, I noted the article, "Merchandise 'Combinations' to Fall Buyers." In this article you tell of large stocks of phono-radio combinations that are available at certain dealers.

I have been wondering if you could furnish me with names of any companies who might wish to sell some combinations at wholesale, or slightly above. We could use quite a few of these here in Alaska and will appreciate any efforts you may make in our behalf.

ROY R. SELFRIDGE  
Vice President

*Service Electric Co., Inc.,  
Ketchikan, Alaska  
(Passed by Censor 13865)*

## More Calls for Tubes

Editor, *Radio Retailing Today*:

... I have received only two tubes in the past five weeks. I can still get condensers and almost any other radio part—but no tubes. I have read of 600,000 tubes being released, but no one knows who is getting them.

I have been reading ever since last February or March in your magazine of tubes to be released as "Victory" tubes, made by seven or more leading tube makers.

If they can make plenty of condensers, etc., they surely can release or make tubes for civilian use. Radio servicemen are quitting everywhere. Will have to find something else soon unless tubes get on the beam. Am I right?

OHIO DEALER

RADIO Retailing TODAY • December, 1943



"Nothing, thanks, we're just browsing."

Reproduced by special permission from *The Saturday Evening Post*,  
Copyright, 1943, by The Curtis Pubg. Co.

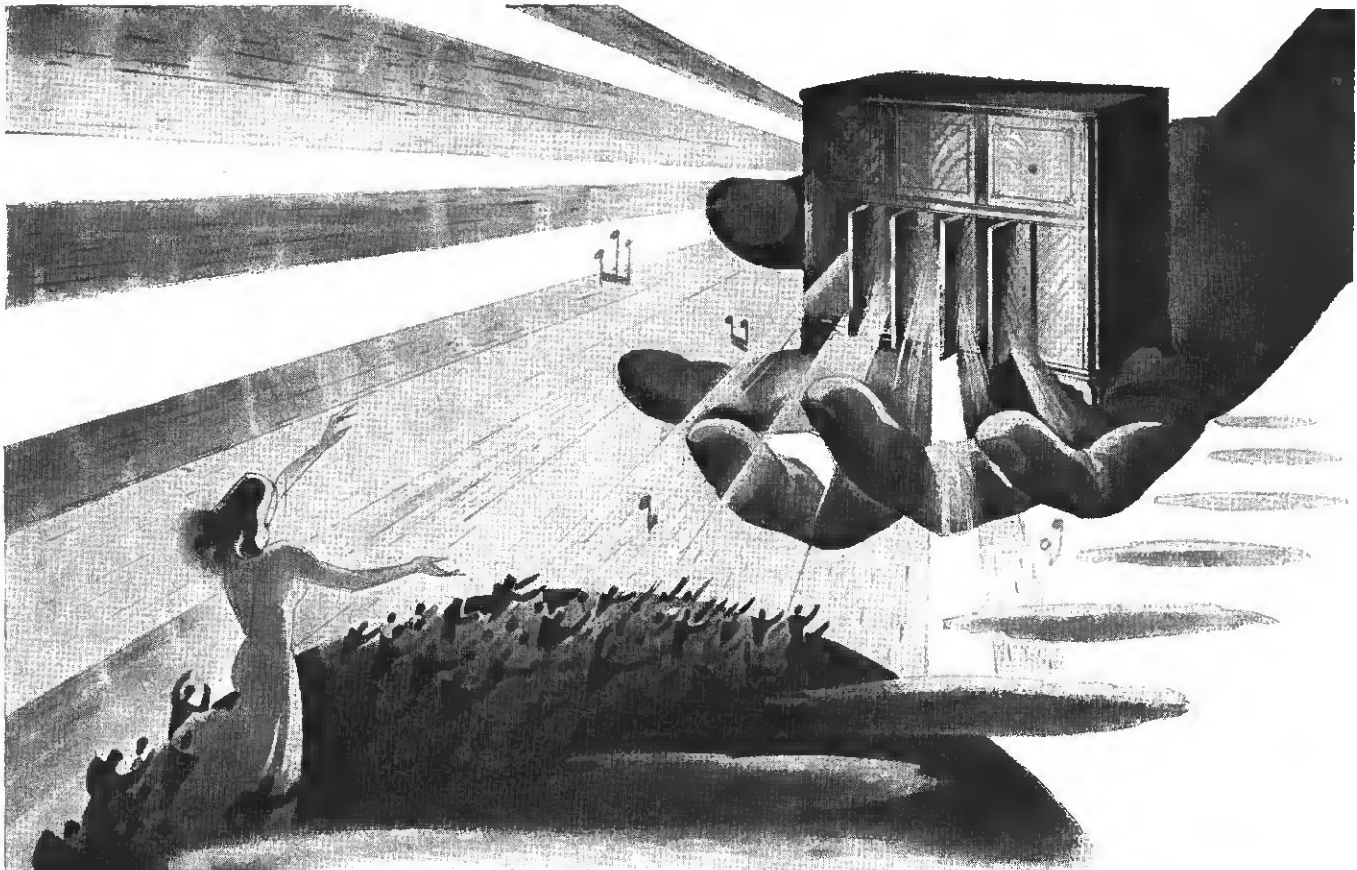

## the *extra measure* of GAROD acceptance

Acceptance was genuine when Garod radios were first introduced in 1922 . . . and it has remained constant ever since. Because of their superior tone and eye-appeal, they sold easily. Because of their equally superior performance, they stayed sold. Then, too, they were a highly desirable group of radios to stock.

Garod's postwar plans call for strict adherence to established policies, but our activities will cover a wider scale. The line will be all-inclusive, ranging from portable midgets to large consoles in both AM and FM, including television and playback and record-changer combinations. You'll receive them in complete "package" units. And they'll provide an attractive proposition since Garods will be sold at fixed price ranges with full distributor and dealer protection. Inquiries regarding postwar franchises are invited.

*Buy an extra measure of security . . . invest in war bonds*

# **GAROD RADIO**

**FOR THE EXTRA MEASURE**

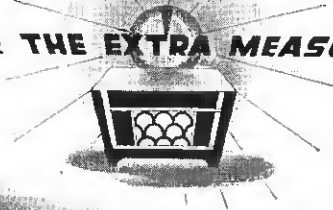

**GAROD RADIO CORPORATION, 70 Washington Street, Brooklyn 1, N.Y.**

## Radio Men In Action

(Continued from page 21)

**BIRMINGHAM, Ala.**—One radio dealer in this city is turning over in his mind the matter of offering for sale radios for postwar delivery. Here is the proposition he is thinking of offering to his customers: "You turn in your old radio now. We will allow you a good price for it to be applied on a new set as soon as available. This will give you preferred delivery. If you should want your money later on, then we will be glad to remit, letting the next customer in line have your preferred rating."

The standing of the concern is such that customers should not be worried about their deposit on the "afterwar" set. The dealer is not sure how the idea will work out but thinks it is worth advertising. He will have the used set to resell, as well as building a backlog of business for the future.

The rub is, a lot of people do not want to turn loose their radios right now. He thinks possibly the scheme will work best just as the war ends and a lot of people will be giving up war jobs, moving back to their old homes, and hence willing to get rid of their radios at that time.

**CHICAGO III.**—Curtis Radio Shop, 2641 No. Cicero Ave., buys, reconditions and sells oil, gas and combination ranges, space-heating stoves and water heaters. Radio repair work is holding up well in the Curtis Shop, according to Geo. R. Curtis, where a practice of circuit-changing solves many scarce tube situations. Though this latter practice is sometimes expensive, the customer is always offered the repair, and according to the proprietor, most people want the work done, and are willing to pay extra.

**MONTGOMERY, Ala.**—Taking an idea from some of the laundries in crowded war production centers, Radio Electric Co. of this city recently closed its doors for several days just to catch up with its business.

"Normally we would be open," said an announcement of the temporary closing, "but due to the present shortage of radio tubes and to the enormous volume of radio service with which we have been favored, we have accumulated approximately 200 radios in our store and are running about three weeks behind on service. Therefore, in order to try to correct this condition and in an effort to get our organization closer to normal, we have decided to stay closed until Friday, Nov. 12."

## ESPEY HONORED



President Harold Shevers of the Espey Mfg. Co., 305 E. 63d St., New York, receives the Army-Navy "E" award for his firm's outstanding production from Lt. Col. Walter B. Brown at New York Times Hall

**TOLEDO, Ohio**—Tiedtke's, department store, whose music section is owned by The Music Sales Co., of New York, is doing a big job with records. The store traffic here runs close to 10,000 customers a day. United Music Stores, used newspaper advertising recently to offer an odd lot of records at 50 per cent off.

**MOBILE, Ala.**—A policy which keeps repairmen continuously on profitable work is followed by Schmohl Bros., radio shop here. This concern makes no estimates, free or otherwise, as to what it will cost to repair a set.

Paul B. Schmohl, who with his brother operates the place, tells why this policy is followed. He insists that an estimate on a job is a poor guess at the best. Furthermore this pre-examination takes mechanics away from the production line. His concern does jobs only on a time and material basis and then it itemizes the work done for the customer.

**SAN FRANCISCO, Cal.**—When all the radios and household appliances were sold and could not be replenished, Milton M. Cohen decided to move to more modest quarters at 149 Turk Street. He secured several government contracts for small items and also is doing thriving business servicing sewing machines and also by selling reconstructed ones.

(Continued on page 82)

## HEARTS AND CUPIDS IN MILWAUKEE!



Colorful albums and the use of Decca dealer aids present a lively window at Hack's in Milwaukee, built around Bing Crosby's recording of "People Will Say We're in Love" (Decca No. 18564)

# Meissner REPLACEMENT PARTS *Available!*

Your Meissner distributor will advise you on the Meissner replacement parts now available . . . while keeping our facilities devoted to the manufacture of vital electronic parts for war needs we have been doing our utmost to keep a replacement parts stock in the hands of Meissner distributors . . . a service which we, here at Meissner, are doing to help keep 'em playing.

See your Meissner distributor today . . . he will tell you just what parts are available now.

  
MT. CARMEL, ILLINOIS

PRECISION-BUILT ELECTRONIC PRODUCTS

## Radio Man & Plane Models

(Continued from page 17)

sound or car radio work. Sold Philco, Emerson and Motorola radios, but ran out of sets last August in meeting the call for radios by local war workers. Uses three different distributors and is strongly in favor of the jobber's position in the field.

### Post-War Plan

Mr. Snyder's alertness in meeting the present business conditions does not claim his entire attention. He is looking to the future, as well. This dealer in these times of post war planning by big business has a post war plan for his own business and is actively working it out right now.

Plenty of men released from the armed forces will have basic training for electronic radio maintenance. He plans to draw from this group of men to continue the excellent repair and servicing for which his shop is known. He is putting aside a set amount each month RIGHT NOW to pay their salaries. Dealer Snyder will then be free to head up his own sales force in the merchandising of refrigerators, appliances and radios to that swell customer list of his!

## Jobbers Man Supply Lines

(Continued from page 25)

nesses, to compare operating experiences. Members frequently report that these two convention opportunities alone have proved highly advantageous to them in many ways. Beyond providing well rounded convention programs, the Association reimburses members for the cost of their first-class railroad and Pullman fares to and from conventions as well as paying substantial attendance allowances.

"Member attendance is uniformly high at all conventions, thus assuring a very broad geographic representation in the views expressed on national matters incident to the industry.

### War Effort Comes First

"Service to the government and the entire industry in cooperation with the war effort, is naturally the princi-

pal current activity. This began pre-Pearl Harbor and is projected well into the postwar era. Really, outstanding work has been done at Washington in furthering the industry's participation in the war program. Much aid to government has been volunteered and still more has been given by direct government request. In all of this effort N.E.W.A. has been entirely industry-minded, thereby benefiting non-members just as well as members.

"Gratifying, indeed, has been the growth in membership this year as a result of the Association's war program. Many electrical wholesalers have wished to participate and contribute their share in this great effort. The roster has increased 25 percent this year.

"Planning for the postwar period is the particular responsibility of the postwar planning committee with

### Jobber Sales Manager



With Zadiart Corp., Cleveland, Ken Bureau is doing everything he can to check up on all future markets for post-war sales. A member of the Civil Air Patrol, Mr. Bureau took first prize recently in the spot landing contest.

especial emphasis being placed on electrical appliances distribution by a special appliance sub-committee. A number of meetings have been held by both committees and some excellent and factual reports are now being made available to the membership.

"Much practical material in this extremely important field is being developed to assist members in prepar-

ing for the transition from war to peace. Electrical appliances, destined as they unmistakably are, to account for a large share of the consumers purchases postwar, are fast becoming principal items of consideration in planning N.E.W.A.'s major programs of industry-wide benefit.

### Making Membership Drive

"An ambitious, energetic campaign seeking to attract electrical appliance distributors to membership in N.E.W.A. is now getting under way. Type of distributors sought to include those in radio, refrigerator, and electronics fields, and distributors of similar types of appliances.

"The vigorous effort we have in mind to make, supported by special publicity, should influence many of these distributors to seek the benefits of N.E.W.A. membership.

"Increasing emphasis on appliance merchandising problems by no means underestimates the continuing importance of electrical supplies distribution so far as N.E.W.A.'s activities are concerned. In fact, the Association's well developed, and long functioning system of commodity committees insures against any diminution of effort so far as electrical supplies are concerned. The 19 committees devoted to supplies items automatically will accelerate their activities as war construction wanes and civilian construction rises with the availability of materials and manpower postwar.

### Consider National Problems

"Thus, under N.E.W.A.'s flexible and practical 'committee' organization, the Association is constantly the means for considering the national problems facing distributors of all electrical goods—whether those goods be a fuse plug or the latest commercially developed electronics device. The great percentage of the membership, voluntarily serving on the 19 commodity committees now functioning, attests to the value the membership places on this activity.

"Other general activities include operating cost studies, a catalog publishing plan, merchandising surveys, operating surveys in the fields of warehousing practices, salesman training, salesman's compensation, use of autos, etc."

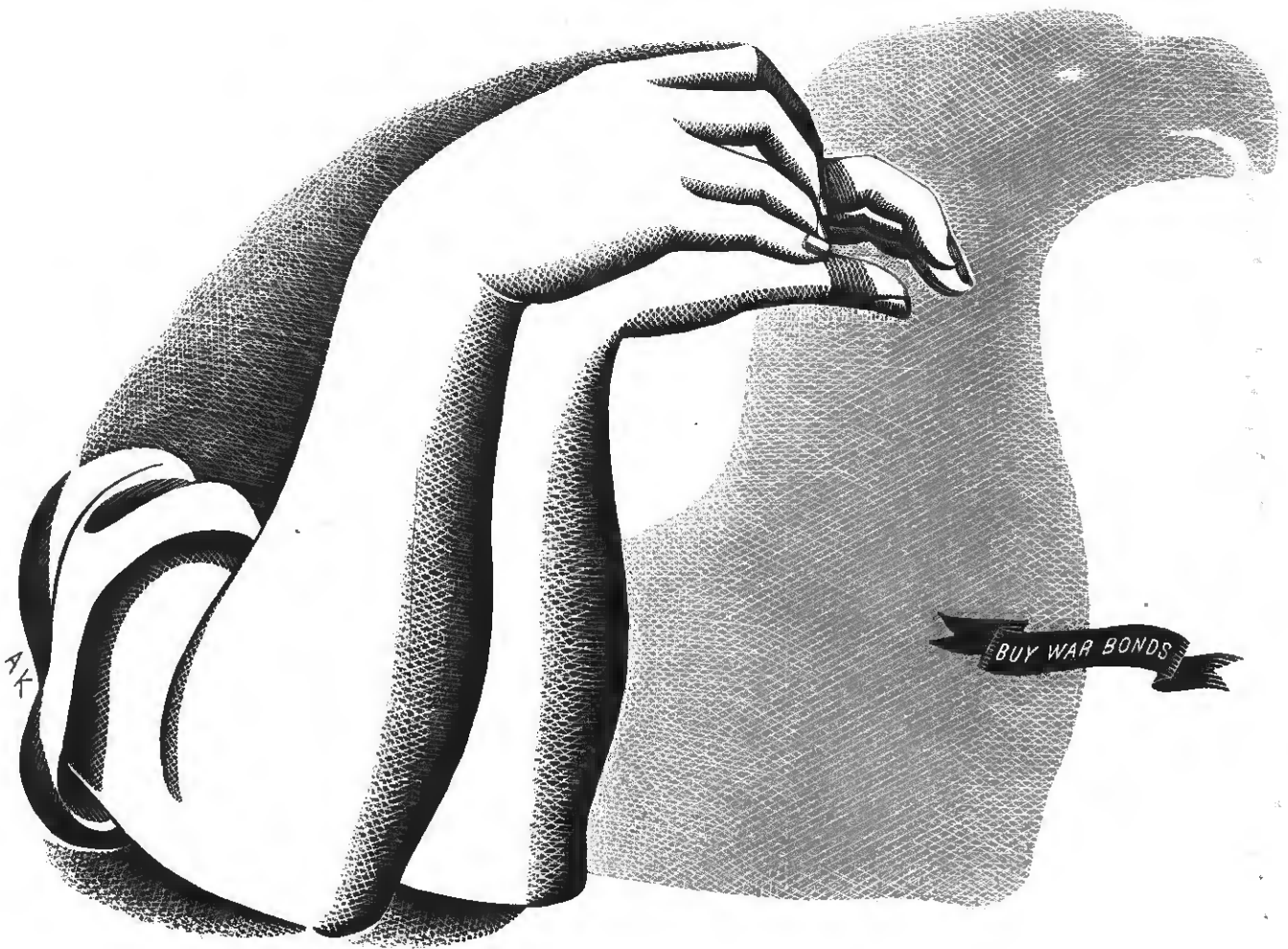

# What happens when a Shadow meets an RCA Electron Tube

**J**UST by itself, it's hard enough to measure to an accuracy of 1/10,000 of an inch. But on a production line, where tens of thousands of wires have to measure up to this accuracy, it's next to impossible—unless you want to spend more time measuring than producing.

However, with a simple electronic device, built around an RCA Electron Tube, thousands of small lead wires for radio tubes are now being checked for such accuracy at the rate of 5 to 8 a minute!

How is it done? Like this . . .

The wire passes before a light. As it does, it casts an enlarged shadow on a sensitive phototube whose output is meas-

ured on a meter. If the wire is 1/10,000 of an inch off, the difference is recorded on the meter and the offending wire can be rejected. If desired, the wire can be rotated to measure out-of-roundness.

This is electronics—the so-called “dream science” of tomorrow—in action today at RCA!

Many of you Distributors and Servicemen can remember when radio, too, was just a “dream.” But you helped that dream “come true.”

Much of the electronic equipment you may be helping to sell, install, or service tomorrow will be built around tubes, circuits, and parts already familiar to you

from your radio days! *Yes, the magic brain of all electronic equipment is a tube...and the fountain-head of modern tube development is RCA!*

#### TUNE IN “WHAT'S NEW?”

RCA's great new show, Saturday nights, 7 to 8, Eastern War Time, Blue Network.



This machine, while used at RCA to measure the diameter of tungsten wires by an electronic method, embodies a basic principle for measuring any critical dimension of any component that can be made to cast a shadow directly proportional to the dimension to be checked.



## RADIO CORPORATION OF AMERICA



# FIRST AID... for wartime radios



### PAPER TUBULARS

Aerovox Type '84 paper tubulars. Individually tested. Extra-wax-sealed. Available in following "Victory" ratings:

D.C.W.V.	CAPACITY
600	.001 mfd.
600	.002 mfd.
600	.005 mfd.
600	.01 mfd.
600	.02 mfd.
600	.05 mfd.
600	.1 mfd.
600	.25 mfd.

Use multiples or combinations for other values.

### ELECTROLYTICS

Aerovox Dandees Type PRS-V electrolytics. Individually tested. Extra-wax-sealed. Available in following "Victory" ratings:

D.C.W.V.	CAPACITY
25	25 mfd.
50	10 mfd.
150	20 mfd.
150	20-20 mfd.
150	50 mfd.
250	20 mfd.
450	10 mfd.
450	10-10 mfd.
450	40 mfd.

Use multiples or combinations for other values.

● In radio servicing, too, many have mastered "First Aid." Thus the bulk of today's capacitor replacements is being handled with these general-utility electrolytics and paper tubulars. And in keeping with this wartime spirit of minimum types for maximum jobs, Aerovox provides these two "first-aid" items: Type PRS-V Dandees or tubular electrolytics, and type '84 paper tubulars. They are now available in the standard "Victory Line" ratings to take care of 90% or better of all standard radio set requirements.

*Ask Our Jobber...*

Ask him about these Aerovox "Victory Line" capacitors for essential servicing. Ask for copy of latest Aerovox catalog—or write us direct.



# Capacitors

INDIVIDUALLY TESTED

AEROVOX CORPORATION, NEW BEDFORD, MASS., U. S. A. • SALES OFFICES IN ALL PRINCIPAL CITIES  
Export: 100 VARICK ST., N. Y. C. • Cable: 'ARLAB' • In Canada: AEROVOX CANADA LTD., HAMILTON, ONT.

## Short-Cuts in Stock-Taking

(Continued from page 19)

them down and correct them later.

Each article should be completely and accurately described, and so recorded on the inventory sheet, so that there is no question of its identification when checked back against invoices to establish correct cost prices.

The count should be "called back" by the recorder, as a cross check on the understanding of the count given by the "counter."

Your inventory sheet should show Fixture No.—Mdse. Description—Quantity—Cost and Extension.

If you count surely, proceed systematically, and check back your count, there should be little trouble in taking the inventory. But this is probably the easiest part of "taking inventory." When the inventory has been recorded, it must still be "figured," and this is the real job.

### Figuring Cost and Totaling

If you do not have a merchandise register, it will be necessary to check each item back against your invoices to establish the correct cost prices. When each item on the inventory sheets has thus been priced, at "cost," the entries must be "extended" by multiplying the cost price per unit by the number of units. This extension should then be entered on the inventory sheet, on the line corresponding to the merchandise. When all extensions have been completed each sheet is totaled, and then the sheet totals are added.

Such are the simple mechanics of "taking inventory." But under existing conditions, much more may also be included.

Many radios have been taken in trade. Some have been stripped of many of their parts for repair of other sets. Many have been put into saleable condition by adding labor and material. Yet your inventory should record the true cost of this merchandise. If your inventory is stated incorrectly, it affects the calculation of your profits and your tax.

For example, you sell a radio for \$100 and take in trade an old set

(Continued on page 68)



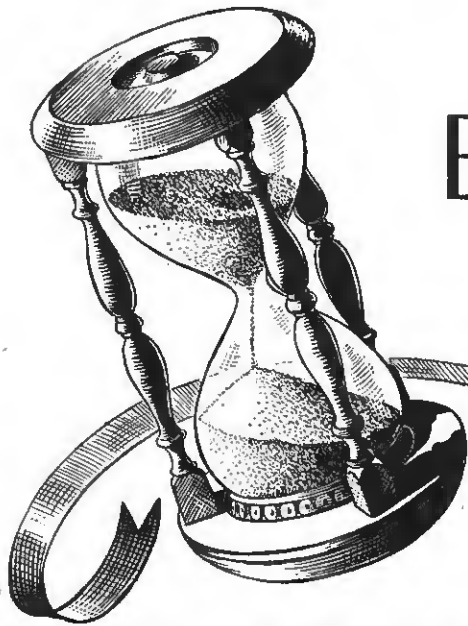

# EXPERIENCE IS LIKE BORROWED TIME

**T**IME itself is the most critical of all our needs today . . . time to make ready the tools and weapons that will insure Victory. We cannot stretch the hours and minutes that lie at hand. But we can borrow from the fruits of the time that has passed — from the years of research stored up by American enterprise.

It is this reservoir of experience that has made possible the prodigious wartime effort of American industry. The Jeeps, the Flying Fortresses, the General Shermans, the Liberty Ships . . . all these, in their vast array, were born of knowledge amassed through many long years of learning.

The same is true of Simpson electrical instruments and testing equipment. They incorporate all that has been learned in the 30-odd years Ray Simpson has devoted to instrument design and manufacture . . . all the experience and know-how of a group of men who have long been associated with him. The biggest single example of what this has achieved is the full bridge type movement with soft iron pole pieces found in every Simpson Instrument. It is an acknowledged finer type of movement refined to its highest expression, and so designed that it permits for the first time all the economies and speed of straight line production.

For today's vital needs, this enables Simpson to build instruments of inherent greater accuracy and stamina, at an unprecedented pace. In the postwar tomorrow, you can rely upon Simpson experience to translate and best apply the many things learned under the impetus of war . . . to provide the utmost in lasting accuracy and instrument value.

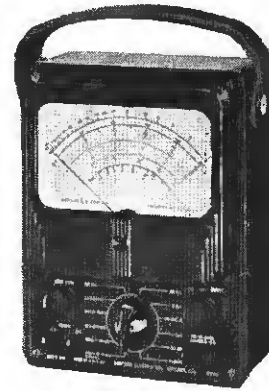

**SIMPSON ELECTRIC COMPANY**  
5200-5218 W. Kinzie Street, Chicago 44, Illinois

# Simpson

**INSTRUMENTS THAT STAY ACCURATE**

*Buy War Bonds and Stamps for Victory*

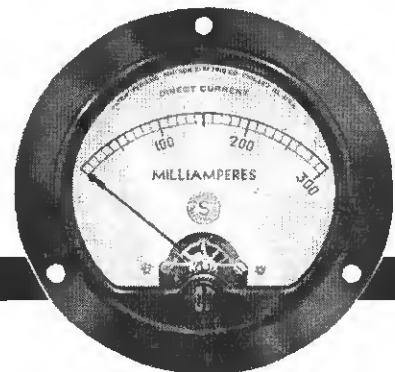

# ±.00WHAT?

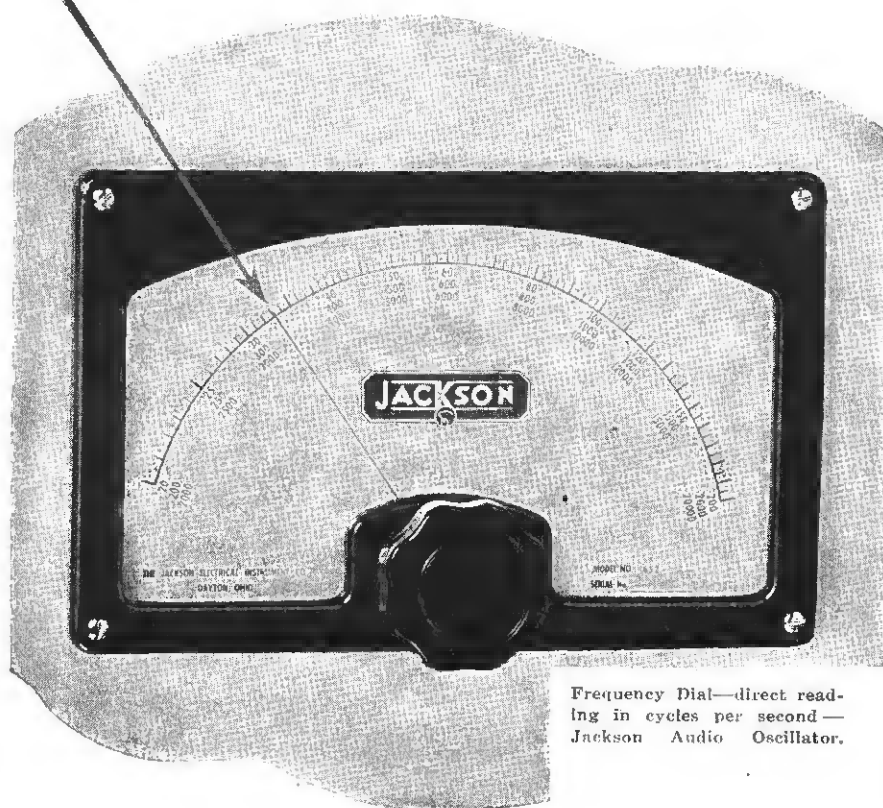

Frequency Dial—direct reading in cycles per second—Jackson Audio Oscillator.

## INTEGRITY OF DESIGN

There is a "hidden" plus feature in all Jackson instruments—that we like to call *Integrity of Design*. Which simply means that—from inception through every stage of development—they are constructed with a view to *performance*, before price.

Every Jackson electrical instrument—multimeter, tube tester, signal analyzer, or whatever—is built to one simple design principle: specified limits of accuracy under anticipated service conditions. In other words,

Jackson instruments are built, first of all, to fit the job. And that spells *Integrity of Design*—whether called by that name, or some other.

Certain Jackson instruments continue available subject to W.P.B. regulations. We still offer a wartime maintenance and repair service for Jackson Customers. Please write us for your needs.

All Jackson employees—a full 100%—are buying War Bonds on a payroll deduction plan. Let's ALL go all-out for Victory.

# JACKSON

*Fine Electrical Testing Instruments*

JACKSON ELECTRICAL INSTRUMENT COMPANY, DAYTON, OHIO

(Continued from page 66)

for \$20. If you record this sale as \$100, your records should show \$80 cash and \$20 merchandise inventory. If you spend \$5 for parts and \$10 for labor, this set should be taken in inventory at \$35. But the transaction *can* be recorded as a sale at \$80, the amount of the cash involved, and the trade-in carried at zero.

Many dealers do this, thinking it is conservative. And it *is*—but when this set is sold, the full amount of the sale becomes *gross profit*, on which you will pay a heavy tax.

And if any substantial part of your stock is in "used" sets, it will be difficult to insure it against fire, if you carry it in inventory at zero, and thus, in case of fire, your loss may be very substantial.

Whatever method you use, it should be consistent, and should not be changed without approval of the Internal Revenue Office. Your inventory is a prime factor in determining your year's operating profits, and thus, your tax. If there are any doubts or questions in your mind, obtain the advice of a competent accountant.

## Refrigerator Idea Men

(Continued from page 42)

The Embassy owners believe that "complete" kitchen ensembles will be the order of the new day, and they believe that with the electric range, automatic washer and electric refrigerator, will be an automatic dishwasher. They point out that in the ultra-modern home, dishwashing will be, as it has been in the past, a bugaboo—and they believe modern homeowners will demand them.

It is the belief of these progressive dealers and servicers that no "radical" designs or mechanisms will be included in the immediate postwar refrigerator models. They believe, however, that many new "gadgets" will come with the first boxes to roll off the lines, and that the first new improvements and developments will be in the refrigerating gases themselves.

They hope, also, that manufacturers will cooperate closer with dealers, particularly in explaining new mechanisms and devices as soon as they are put on the market.

**IRC RESISTORS ARE**

**STAR PERFORMERS**

**FOR UNCLE SAM, TOO!**



IRC now proudly flies a second White Star on its "E" pennant for "great and continuing contribution to the cause of freedom."

Alert Service Men and other users of radio parts know that the resistance units overwhelmingly preferred for war equipment today are the same components that will be specified by manufacturers as original equipment in tomorrow's electronic devices. Already surveys indicate that IRC resistors and controls will help you meet the demands of this vast civilian market.

**INTERNATIONAL RESISTANCE COMPANY**

DEPT. P. 401 NORTH BROAD STREET, PHILADELPHIA 8, PA.



# Thinking of after the War?

We want to make the acquaintance of dealers and distributors alert enough to do their post-war planning now; men and organizations who will recognize the sweeping post-war sales potentials of the high fidelity tape recorders bearing the Fonda name.

Here are a few Fonda features that will explain why our instruments will be in demand—high quality recordings at low cost; continuous recording for eight hours without supervision; automatic instantaneous playback; provides a permanent, indestructible record. The Fonda method of recording is based on our own exclusive patent which is the result of years of engineering and development effort.

Let's start getting acquainted today by dropping us a note requesting our free literature!

# Fonda

## THE FONDA CORPORATION

245 EAST 23RD STREET, NEW YORK 10, N. Y.

*Designers and Manufacturers of Precision Recording Equipment*



The Fonda Recorder  
for the Home



The Fonda Recorder  
for monitoring by  
Commercial Airlines and  
Radio Broadcast Stations



The Fonda Recorder  
for Industry

## Tracey Pleased With Survey on Majestic

Men and women, numbering into the thousands, in seven of the country's largest cities, formed the basis of an investigation conducted by Ross Federal Research Corp., for Majestic Radio & Television Corp., Chicago.

Majestic's President, E. A. Tracey described the survey as a means of accurately measuring the postwar Majestic potential, in an effort to inaugurate a fundamentally sound program for re-conversion at the time the war ends.

### **Detailed Figures Withheld**

While the Ross Federal field investigations incorporated other findings—the main issue to be measured was ownership and confidence in the name of "Majestic—Mighty Monarch of the Air." An official statement says that "The Company is withholding detailed figures for release in a special campaign . . . but this much can be told:—the degree of penetration of the market was within 5½% range in four of the major cities. The startling fact was that of the men and women approached—in department stores, railroad stations, neighborhood shopping areas, etc.—29.2% had owned or now own a Majestic radio."

"This survey reflects a market position so much stronger than previous 'spot-checks' had revealed," Mr. Tracey said, "that the company is justified in establishing postwar potentials far in excess of normal, and it is our intention to enlarge Majestic's sales and advertising strategy to acquire a far stronger postwar standing."

## Seabee Writes Ken-Rad

Roy Burlaw, president of Ken-Rad Tube & Lamp Corp., Owensboro, Ky. recently received a letter from Ronald Crabtree, a "Seabee" stationed in the southwest Pacific. A portion of the letter follows:

"Yesterday, while watching a cargo ship being unloaded here at one of America's advance bases, I couldn't keep from noticing a large box coming off the ship—on it was inscribed 'Ken Rad, Owensboro, Ky.' It brought back memories of the greatest city in the world, my home. Just for a moment I could almost see the lights burning on Main Street."

## J. V. Conlin Is Promoted

J. V. Conlin, advertising manager of the Ray-O-Vac Company, makers of dry batteries, has been named public relations representative. His new work will embrace supervision of all relations between the company and the public, including advertising, news and public meetings.



*"Merry  
and Christmas  
Happy New Year"*

Such sentiment can have full meaning only when tolerance, decency and justice again rule the world. On this Christmas Day 1943 our men on the battlefronts are fighting to preserve these values.

Let us at our benches, machines and desks dedicate ourselves to the same fight. Let us work to hasten the day when our men and women at the front can return home—home to new years full of promise and to other Christmases really bright!

The men and women of Jensen pledge themselves to do their part.



**Jensen**

RADIO MFG. CO. • 6601 SO. LARAMIE • CHICAGO 38, ILLINOIS  
*Makers of Fine Acoustic Apparatus and Precision Instruments*

## New G. E. Appointments

H. A. Crossland has been named manager of sales of the receiver division of the General Electric Company's electronics department, according to an announcement by I. J. Kaar, division manager. In this capacity, Mr. Crossland will be responsible for all sales matters of the division. For the present he will divide his time between Bridgeport, Conn., and Schenectady, N. Y.

E. H. Fritschel has been named sales manager of transmitting tubes, and H. J. Mandernach, sales manager of

receiving tubes in the tube division of the General Electric Company's electronics department, according to an announcement by G. W. Nevin, division manager. Both men are located in Schenectady, N. Y.

## Solar Appoints McKinley

J. E. McKinley, 401 No. Broad St., Philadelphia, has been appointed sales representative for Solar Capacitor Sales Corp., in eastern Pennsylvania, Maryland and the District of Columbia.

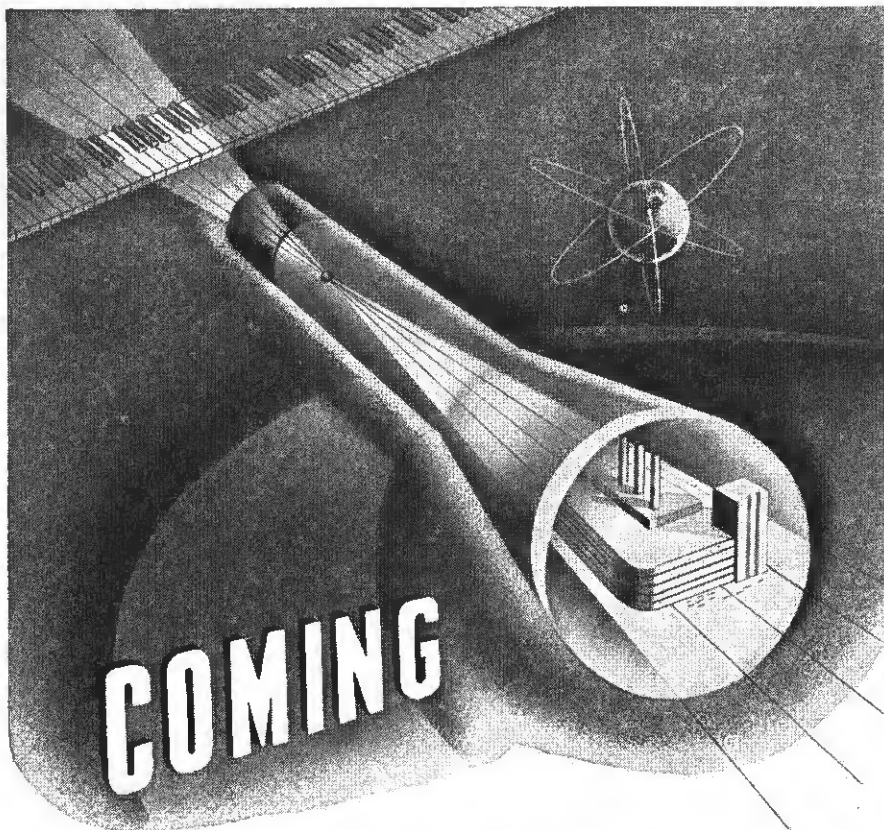

The utilization of the electron through the agency of the vacuum tube is one of Ken-Rad's many contributions to the science of Electronics in war. These electronic discoveries will be at the disposal of industry—in hundreds of developments — immediately after the Peace

# KEN-RAD

TRANSMITTING TUBES  
CATHODE RAY TUBES

INCANDESCENT LAMPS  
FLUORESCENT LAMPS

METAL AND VHF TUBES  
SPECIAL PURPOSE TUBES

OWENSBORO

KENTUCKY

U S A

72

## Norge Official Forecasts Big Peacetime Production

His forecast based on an "accumulated shortage of appliances in civilian hands" and a backlog of active export inquiries for record-breaking shipments



Howard E. Blood

later to foreign countries, Howard E. Blood, president and general manager of the Norge Division of Borg-Warner Corp., says that his company will make "25 to 40 per cent more refrigerator washers, ranges and other household appliances in the first year after postwar production hits full stride than in any previous year.

"The American public will buy millions of these appliances which will be sufficient to keep the industry going at full strength for an extended period of time," Mr. Blood said. "Surveys of distributors and dealers throughout the United States reveal an amazing shortage, especially in war production areas."

Mr. Blood said that immediate postwar appliances will contain minor improvements over the 1941 and 1942 models but will not offer radical "stratospheric changes in design as visualized by the artists.

"The need for getting into production quickly will leave little time for developing radically new models," Mr. Blood explained.

## Appoint H. E. Warren Manager

Harry E. Warren, manager of the refrigerator sales division of Edis General Electric Appliance Co., Inc., maker of Hotpoint electric appliances, has been appointed manager of the advertising division of Hotpoint, effective immediately, according to G. H. Smith, general sales manager.

Mr. Warren takes over his new position after six years with the Hotpoint organization, during which time he served first as sales manager of the home laundry division and more recently as manager of the refrigerator sales division.

RADIO Retailing TODAY • December, 1945

MEASURES THE *new* MAINTENANCE VALUES

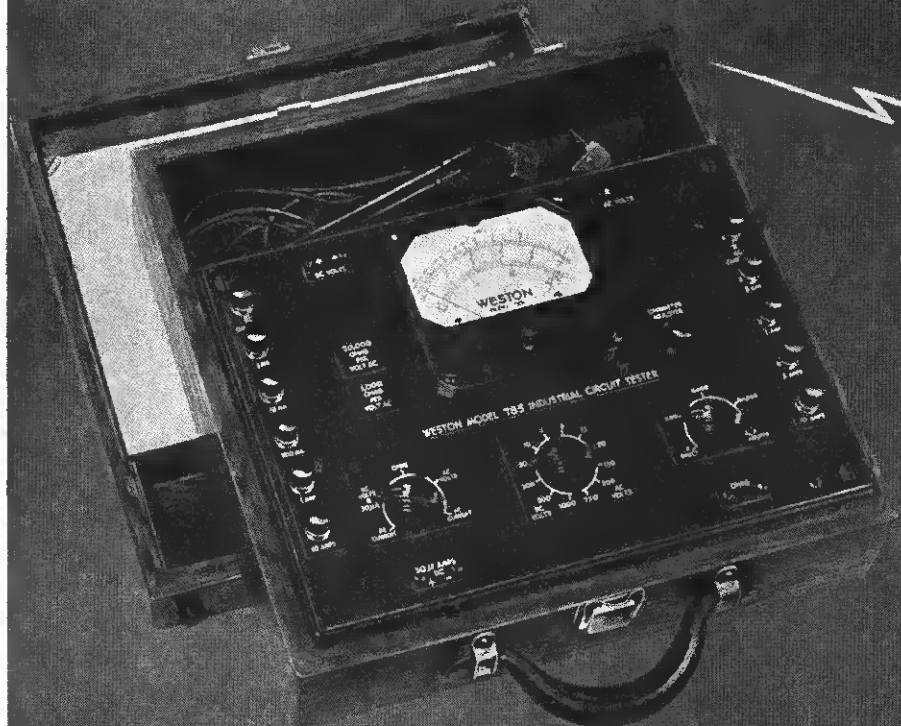

as well as  
the old...



## Weston MODEL 785 Industrial Circuit Tester

### RANGES

**D-C Voltage**—Measurements from 10 millivolts to 1000 volts (20,000 ohms per volt) in full scale ranges of: 1/10/50/200/500/1000 volts. (Up to 5000 volts with very compact external multiplier.)

**A-C Voltage**—Measurements from 0.1 to 750 volts (1000 ohms per volt) in full scale ranges of: 5/15/30/150/300/750 volts.

**D-C Current**—Measurements from 0.5 micro-ampere to 10 amperes, in full scale ranges of: 50 microamperes, 1/10/100 milliamperes, 1/10 amperes. (Higher ranges with external shunts.)

**A-C Current**—Measurements from 10 milliamperes to 10 amperes, in full scale ranges of: .5/1/5/10 amperes. Higher ranges, up to 1000 amperes, with external current transformers.

**Resistance**—Measurements from 0.5 ohm to 30 megohms in full scale ranges of: 3,000/30,000/300,000/3 meg./30 meg. Center scale values are: 25/250/2,500/25,000/250,000 ohms.

• The growing use of electronic devices and other sensitive circuits throughout industry poses no new instrument problems for contractors or maintenance departments WESTON equipped. The familiar Model 785, with its high sensitivity and broad range scope, answers these newer measurement requirements. But more . . . it also covers most of the usual maintenance needs.

Model 785 furnishes another example of WESTON'S engineering foresight . . . designing instruments always with the needs of to-morrow in mind. Other WESTONS, equally important for efficient maintenance in the days to come, are the time-saving WESTON Clamp Ammeter, and the WESTON foot candle meters which measure all types of lighting direct . . . without correction factors. Weston Electrical Instrument Corporation, 597 Frelinghuysen Avenue, Newark 5, New Jersey.

Laboratory Standards . . . Precision DC and AC Portables . . . Instrument Transformers . . . Sensitive Relays . . . DC, AC, and Thermo Switchboard and Panel Instruments.

# WESTON

Specialized Test Equipment . . . Light Measurement and Control Devices . . . Exposure Meters...Aircraft Instruments... Electric Tachometers...Dial Thermometers.

**FOR OVER 55 YEARS LEADERS IN ELECTRICAL MEASURING INSTRUMENTS**

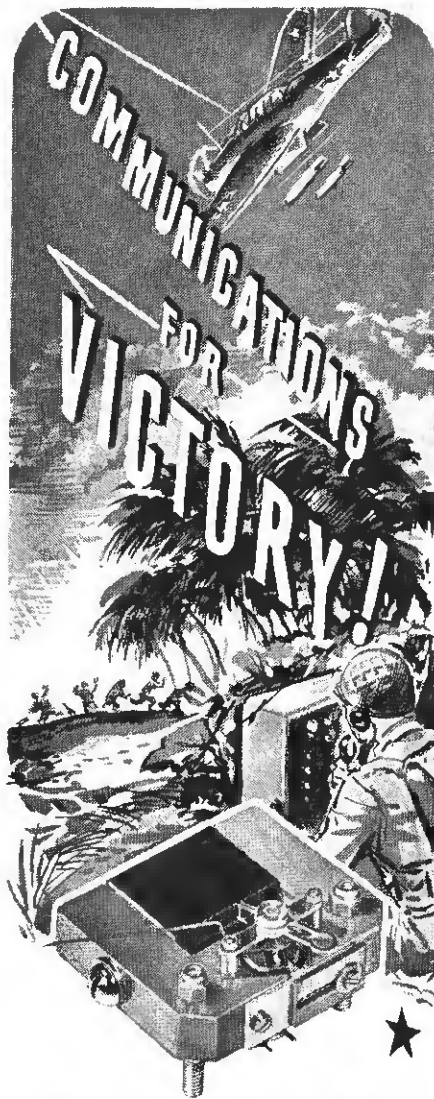

Supreme's New "Hairline Accuracy" Meter

**ALLIED LIVES...** Allied victories.. depend upon the Communication waves and wires. These channels of contact **must** be kept open. Our fighting men rely on the accuracy, dependability and ease of operation of Supreme Instruments and Meters, assured by Supreme's 15 years of experience. **Supreme Radio Testing Equipment Keeps Communications Open.**

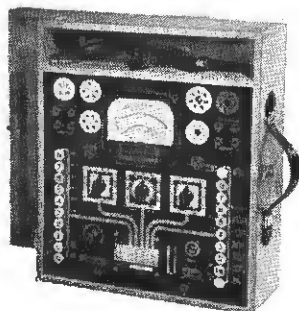

Supreme 504-A Tube and Set Tester

**SUPREME**  
 SUPREME INSTRUMENTS CORP.  
 GREENWOOD, MISSISSIPPI, U. S. A.

## New Designs and Features Promised by Garod

Currently engaged 100 per cent in war production, the Garod Radio Corp., Brooklyn, N. Y., is nevertheless looking to the future. A series of postwar plans have just been announced by Lou Silvers, sales manager.

"The Garod postwar line will be stronger, more comprehensive, and more desirable than at any other time in our history," says Mr. Silvers. "We'll be ready with new designs, new features, and wider price ranges, including portable midgets, table models, consoles, AM and FM, television sets, play-back and record changer combinations. There will be a model for every requirement and a price for every purse. In addition, each group will be sold at fixed price ranges with full dealer and distributor protection. In short, we won't sell our customers short, we'll see to it that they will not be forced to compete in a reckless price-cutting market."

## Sonora Announces New Postwar Pay Program

The formulation of an unemployment compensation program to help solve postwar unemployment problems was recently announced by the Sonora Radio & Television Corp., Chicago, now manufacturing aircraft communications equipment.

Under the Sonora plan, payment of \$20.00 per week for a maximum of 18 weeks will be made in the event any employee is laid off. Such payments will begin after the 18 weekly payments from the state; or if for any reason the state payments are not made to the employee, payments from the Sonora fund will begin immediately.

### Company Pays the Cost

The entire cost of the unemployment compensation fund, which was created primarily to care for employees who are without employment due to conversion of the plant from war production to peacetime activity, is taken care of by the company. No contribution or payroll deduction is required from any employee.

"If every industry in the nation would promptly adopt a similar plan, I am sure we can avoid any serious unemployment problem after this war," Joseph Gerl, president of Sonora, said. "It has been our experience," he pointed out, "that funds contributed by the company are deductible as legitimate expense on war contract negotiations and from corporation taxes."

One of the outstanding features of the plan is that employees in the armed forces will be eligible for benefits of the fund upon their release from the service. In the event they have given their lives, the Sonora plan calls for payment of a sum equal to 18 weeks unemployment compensation to next of kin.

## Hackbusch Rejoins Stromberg-Carlson, Canada

Ralph A. Hackbusch, vice-president in charge of radio and director of the radio division of Research Enterprises Ltd., founded in 1940 by the Canadian government to undertake research and the manufacture of radio optical glass and other war equipment, has rejoined the Stromberg-Carlson Company of Canada in a new capacity as vice-president and managing director, it was announced recently by Lloyd L. Spencer, president.

Mr. Hackbusch served on the staff of the Canadian Westinghouse Company for 13 years, was associate radio engineer for Kolster Radio for 3 years, and joined Stromberg-Carlson in 1936 as radio engineer-in-charge. A few years later he was elevated to the position of chief engineer, later to the position of chief engineer-and-factory-manager, and in 1939 was elected a director and named vice-president and general manager.

## "Reps" Map Out Full Schedule at Meeting

At the recent meeting of Mid-Lantic Chapter of the Representatives of Radio Parts Manufacturers, Inc., Philadelphia, held at the Engineer's Club a planning committee, under the chairmanship of S. K. Macdonald was formed. This committee working with the Chapter's president, L. D. Lowery, will consider not only postwar possibilities of the Mid-Lantic Chapter, but will make immediate recommendations regarding publicity for the local organization, and a new buyer's guide which will be a revised edition of the "Classified Index" published last year.

A membership committee was appointed by Norman M. Sewell, vice-president, presiding in the absence of President L. D. "Doc" Lowery, consisting of Chairman Roy Bengé, John McKinley, and Robert Williams. The membership goal is set for 50, and new members are being added at each meeting. Bob Williams and Don Gawthrop were accepted as new members at the last meeting.

## Distribute Hearing Aid

Stern & Company, Hartford, Conn., distributors of Zenith Radios, and electrical specialties, have been appointed distributors of the new Zenith radionic hearing aid, according to an announcement made by F. E. Stern. Territory assigned to this distributor is Connecticut, Vermont and western Massachusetts.

The hearing aids will "reach the general public only through the opticians and optometrists in our territory," Stern & Company advise.



## Frank M. Folsom, New RCA Head at Camden

Frank M. Folsom, who had been chief of the Procurement Branch of the Navy Department, has been elected a vice-president and a director of Radio Corporation of America, according to an announcement by David Sarnoff, president. Mr. Folsom will be in charge of the company's manufacturing division, RCA Victor, with prin-

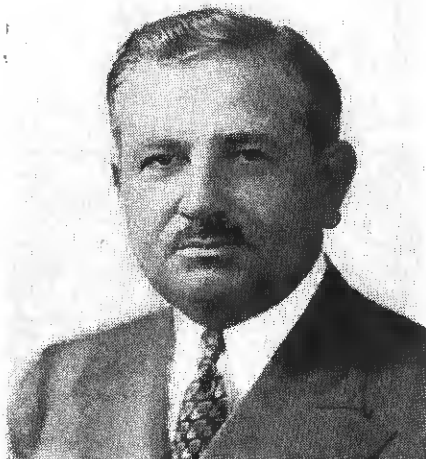

With years of experience in retailing, Frank M. Folsom will assume duties Jan. 1st, in charge of RCA Victor's manufacturing Division.

cipal plants in six cities and headquarters at Camden, N. J. He will assume his new duties January 1.

Mr. Sarnoff also announced that the Board had accepted with regret the resignation of George K. Throckmorton as an RCA vice-president and director. Mr. Throckmorton, present head of the RCA Victor Division, is retiring for reasons of health, but will continue as a consultant to the company.

### Famous as Merchandiser

Except for services during this and the first World War, Mr. Folsom's career has been in retail, mail-order, and chain-store distribution. Born in Sprague, Wash., 49 years ago, and educated in public schools in Oregon, he started in business with Lipman Wolfe & Co., Portland, Oregon, then went with Hale Brothers, San Francisco.

Just before and immediately after serving with the Air Corps in World War I, he was with Weinstock, Lubin & Co. of California. He rejoined Hale Brothers in 1923 and became heir general manager. In 1932 he became Pacific Coast manager for Montgomery Ward's mail-order and retail stores, and one year later became vice-president in charge of merchandise, and a director of Montgomery Ward with headquarters in Chicago. He remained with that organization for eight years.

Do You Need

# RADIO TUBES NOW?

We have "HARD-TO-GET" and "HARD-TO-FIND" Tubes available and coming in every day. Over 100 different tube numbers. Join our list of preferred customers by writing for those tubes you've been trying to obtain. Tubes for Ray Guns, Phonographs, and all types of Coin-Operated Machines.

### These Are Some of the Numbers Now Available NET PRICES

OZ4	.....	\$1.65	6Z4/84	.....	\$1.10
1Q5GT	.....	1.65	7A8	.....	1.35
2A3	.....	2.00	7B7	.....	1.35
3Q5GT	.....	1.65	7F7	.....	1.65
5Y3/GT	.....	.75	83	.....	1.35
6A7	.....	1.00	84/6Z4	.....	1.10
6A8	.....	1.35	12SK7GT	.....	1.10
6C5	.....	1.15	12SQ7	.....	1.00
6D6	.....	1.00	12SQ7GT	.....	1.10
6F6	.....	1.15	2051	.....	2.60
6H6/GT	.....	1.15	24A	.....	.90
6J5	.....	.95	25L6GT	.....	1.15
6J5GT	.....	.95	26	.....	.75
76	.....	.95	27	.....	.70
77	.....	.95	35/51	.....	1.00
78	.....	.90	37	.....	.90
6K7G	.....	1.15	42	.....	.90
6N7/GT	.....	1.65	43	.....	1.10
6Q7/GT	.....	.90	50L6GT	.....	1.10
6SK7	.....	1.05	56	.....	.85
6SQ7	.....	1.05	57	.....	.95
6SQ7GT	.....	1.15	117Z6/GT	.....	1.65
6V6GT	.....	1.15			

We Have Many Other Tube Numbers! Every order subject to prior sale. WPB LIMITATION ORDER No. L265 makes "Supplier's Certificate" mandatory with each order.

ALL SHIPMENTS EXPRESS C.O.D.  
DO NOT SEND CHECK OR MONEY ORDER.

## CHICAGO NOVELTY COMPANY, INC.

1348 Newport Avenue

Chicago 13, Illinois

For IMMEDIATE and POSTWAR MARKETING . . .

- Uptodate listings of new sources of supply for many radio products.
- Reaches all important wholesalers, retailers, department store buyers, service dealers, etc.
- The only radio trade directory that lists all classes of products for Distribution as well as Servicing.
- Use advertising space to—Amplify your free listing; catalog your product; explain deliveries; keep trade contact, etc.
- Protect your space requirements by making reservation now. Space will be limited because of paper rationing.

advertise in the

1943-44 RADIO YEAR BOOK &  
RADIO TRADE DIRECTORY  
to be published in March as a section of

**RADIO**  
*Retailing*  
**TODAY**

Caldwell-Clements, Inc., 480 Lexington Avenue, New York 17, N. Y.

## Annual Radio Division Dinner Held in New York

The annual radio dinner, climaxing the efforts of the radio, music, refrigeration and allied industries on behalf of the New York and Brooklyn Federations of Jewish Charities, was held at the Hotel Commodore, December 2nd. More than 600 attended.

Ben Abrams, of Emerson Radio, chairman of the radio division, saw his forecast of "the most successful dinner in the history of the radio division" come true. Abe Bloom, of General Instrument Co., Max Kassover, of Vim Electric Co., and Jules M.

Smith, of Davega's were chairmen of the dinner committee. Major-General Wm. H. Harris, of the U. S. Signal Corps was the principal speaker.

### Names of Committeemen

The committee on arrangements, serving under Messrs. Bloom, Kassover and Smith consisted of:

Henry Benjamin, Davega-City Radio, Inc.; Bernard D. Colen, Colen-Gruhn Co.; Lewis E. Dorfman, Continental Radio Telev. Corp.; Isidor Goldberg, Pilot Radio Corp.; Benjamin Gross, Gross-Sales, Inc.; Murray Gruhn, Colen-Gruhn Co.; Henry Halperin, Air

King Radio Co.; Jacob P. Lieberman, Air King Radio Co.; Jack M. Marks, Fada Radio, Perry Saftler, Irving Sarnoff, Bruno-New York, Inc.; Georg J. Seedman, Times Square Stores Corp.; Harold Shevers, Espey Mfg Co.; Lou Silver, Garod Radio Corp. Herman M. Stein, Davega-City Radio Inc.; David Wald, DeWald Radio Co and M. W. Weintraub, Garod Radio Corp.

Other members of the dinner committee were: Sid Baum, Ed Berger, Eby Specialty Co.; Sam Blalek; William Brand, William Brand & Co.; William Carduner; Michael Cohen, Davega-City Radio, Inc.; Samuel Cohen, General Instrument Co.; Maurice Despres, Dal Radio Co.; Adolph Friedman; Sol W. Gross, Emerson Radio & Phono. Co. Jerome Harris, Bruno-New York, Inc. Alexander P. Hirsch, Micamold Radio Corp.; Benjamin Kosowitz, Liberty Music Shops; Maurice Landay; Samuel W. Lerer, Lerer & Lerer; Louis A. LeWinter, LeWinter's Radio Stores Inc.; Philip Masters, Masters Mart; William Nauberg, Jr. William Brand & Co.; Oscar W. Ray, Times Appliance Co.; Moe Sachs, Lewis & Sachs Charles Sonfield, Bruno-New York Inc.; David Sonkin; Joe Sprung; Jules Sussman; Louis Titefsky, European Radio Co.; Duke Wellington, Fada Radio and E. A. Wildermuth.

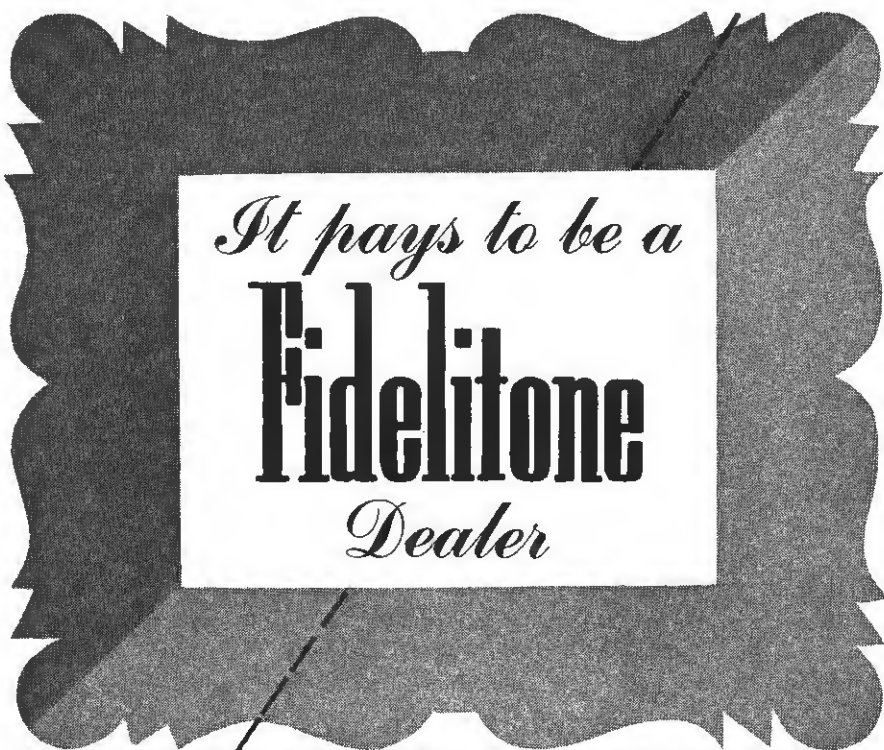

There are more Fidelity phonograph needles in use today than all other long life needles combined. Phonograph owners have voted Fidelity their favorite needle by their purchases. The Fidelity Line is easy to sell because Fidelity needles are half sold when dealers get them. Every Fidelity dealer is backed by constant national advertising, free literature, attractive window and counter displays, and many other sales helps.



**FIDELITONE DE LUXE FLOATING POINT** ... the needle with the famous Permetal Tip, an alloy four times as costly as gold. Kind to records. 5000 plays. Floating point construction filters record scratch. Cat. No. 100.

**FIDELITONE FLOATING POINT** ... a needle patterned after the Fidelity De Luxe but with a less costly alloy tip. Will play up to 1000 sides of standard records. Floating point construction to filter record scratch. Cat. No. 5024



**PERMO RECORDING STYLUS** ... a professional type recording stylus of superior quality. More than 400 six-inch recordings from one stylus. For better recordings.

**DE LUXE FIDELITONE LONG LIFE** ... specially designed for playing back home recordings. A flat area on the shank permits removal and proper reinsertion. Will reproduce over 4000 home recording discs. Cat. No. 25

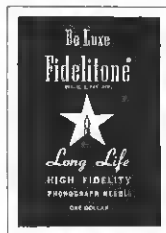

## Sylvania Buys Land

The purchase of a 28½-acre tract of land adjoining the Clearview Golf Course at Bayside, New York, for a research center was announced recently by officials of Sylvania Electric Products Inc., manufacturers of radio electronics and lighting products.

Because of wartime restriction there will be no immediate building program, although two structures now on the property will be renovated for use by a small research group.

## He Gets Action!



William J. Nezerka, secretary-treasurer in charge of sales for The Turner Co. Cedar Rapids, Iowa, is filling a big-time job efficiently.

**PERMO PRODUCTS CORPORATION 6415 Ravenswood Ave., Chicago**

## Music War Council Names State Chairmen

To promote local interest in the "Music for Victory" movement, the Music War Council of America, with headquarters at 20 East Jackson Blvd., Chicago, is appointing state chairmen in each of the 48 states. Those who have accepted appointments to date, include the following:

ARKANSAS: W. P. Hamilton, Houck Music Co., 113 E. Fourth St., Little Rock. IDAHO: Harold G. Aggeler, Music Center, 905 Main Street, Boise. INDIANA: Frank O. Wilking, Wilking Music Co., 120 E. Ohio Street, Indianapolis. IOWA: Edward A. Schmidt, Schmidt Music Co., 113 W. 3rd St. Davenport. KENTUCKY: Charles H. Meredith, Shackleton Piano Co., 307 N. Broadway, Louisville. LOUISIANA: Parker M. Harris, Philip Werlein, Ltd., 305 Canal St., New Orleans. MARYLAND: Ernest R. Fink, Hecht Bros., Howard & Franklin Sts., Baltimore. MICHIGAN: N. E. Hager, Hager Music House, 7 Division Ave., North, Grand Rapids. MISSISSIPPI: W. M. Smith, Smith's Music Store, 120 W. Capital St., Jackson. MISSOURI: F. D. Streep, Jr., Streep Music House, 920 Grand Ave., Kansas City. NEBRASKA: Edw. J. Walt, Jr., Edw. J. Walt & Sons, Inc., 1140 "O" St., Lincoln. NEVADA: J. W. Garehime, Garehime Music Company, 114 N. 3rd St., Las Vegas. NEW YORK: S. L. Carroll, Clark Music Co., 416 S. Salina St., Syracuse. NORTH CAROLINA: J. L. M. Smith, Greensboro Music Co., 207 W. Market St., Greensboro. NORTH DAKOTA: A. J. Daveau, Daveau, Music Co., 613 First Ave., N., Fargo. OHIO: Roy D. Wells, 135 So. Southampton Ave., Columbus. RHODE ISLAND: C. Walter Fraleigh, The Shepard Co., 259 Westminster St., Providence. SOUTH DAKOTA: A. E. Godfrey, Williams Piano Co., 218 S. Main St., Sioux Falls. UTAH: Thomas J. Holland, Glen Bros. Music Co., Salt Lake City. VERMONT: L. S. Cummings, Vermont Music Co., 184 N. Main St., Montpelier. VIRGINIA: Marshall T. Miles, The Miles Music Company, 35 Court Square, Harrisonburg. WASHINGTON: C. E. Hollenback, Hollenback Piano Co., 167 S. Howard St., Spokane. WEST VIRGINIA: S. H. Galperin, Galperin Music Co., 17 Capitol St., Charleston.

## War and Postwar Discussed At Chicago Meeting

In Chicago recently for an important two-day conference with executives of the Admiral Corp. were Lee H. D. Baker of Washington, D. C., Maurice S. Despres of New York, Harry Lever of Atlanta, and Lou Willis of California. Ways and means of speeding up the delivery of critical war materials was the No. 1 topic of discussion at the conference, followed by a round-table exchange of views on the subject of Admiral postwar planning.

**ARMY E NAVY**

**BELL SOUND SYSTEMS**

TWO symbols of excellence—each recognized as a mark of achievement in attaining and maintaining highest standards of performance.

BELL SOUND SYSTEMS—the name of quality in Permanent and Portable Amplifying Equipment... Industrial Voice-Paging and Broadcasting Systems... Recording and Disc-Playing Units... Electronic Devices.

**BELL SOUND SYSTEMS, INC.**  
1186 Essex Ave., Columbus 3, Ohio  
Export Office: 4900 Euclid Ave., Cleveland 3, Ohio

## WARTIME RADIO SERVICE

This booklet includes the following—  
Nearly 300 Tested Substitutions for All the  
Hard to Get Types of Tubes

Gives instructions for Building Inexpensive Apparatus for Repairing Open Heaters in 150 Mill Heater Type Tubes and How to Use It. About 40% of These Tubes Can Be Made to Give Additional Service.

Tells How to Change the Late Farm Radios for Electric Operation. Diagram and Text Eliminate the Bugs.

The only book of its kind—saves you valuable time, enables you to increase your sales and satisfy your customers. You can't afford to figure-it out yourself.

\$3.00 per copy, postpaid

**CITY RADIO COMPANY**

The RADIO CITY of Phoenix, Arizona  
504-6 E. Washington Street

# "THE HELP SITUATION" by Lariat



Tired of training help that's either too young or too old to know the latest in high-speed servicing techniques?—What radio serviceman isn't?

That's why more and more of them are turning to *Rider Manuals* and *Rider Books* for up-to-the-minute information to speed the diagnosis of faulty radio receivers.—And to help in turning out the huge volume of work they have today. You can depend upon the help that *Rider Books* offer you.

Every book listed at the right should be in your library or on your service bench today. Available at all good radio jobbers throughout the world, these *Rider Publications* will be augmented during the coming spring by *Rider Manual Volume XIV*. Better reserve your copy of Vol. XIV in advance—when you order those other *Rider Books* you need.

Better do it today!

## HERE'S HELP THAT'S "Hep!"

**RIDER MANUALS 13 VOLUMES**  
 Volumes XII to VII.....\$11.00 each volume  
 Volumes VI to III..... 8.25 each volume  
 Abridged Manuals I to V (1 volume)...\$12.50  
 Automatic Record Changers and Recorders... 6.00

**OTHER RIDER BOOKS YOU NEED**  
 The Cathode Ray Tube at Work  
 Accepted authority on subject.....\$3.00  
 Frequency Modulation  
 Gives principles of FM radio ..... 1.50  
 Servicing by Signal Tracing  
 Basic Method of radio servicing ..... 3.00  
 The Meter at Work  
 An elementary text on meters ..... 1.50  
 The Oscillator at Work  
 How to use, test and repair ..... 2.00  
 Vacuum Tube Voltmeters  
 Both theory and practice ..... 2.00  
 Automatic Frequency Control Systems  
 —also automatic tuning systems ..... 1.25  
 A-C Calculation Charts  
 Two to five times as fast as slide rule.  
 More fool-proof. 160 pp. 2 colors..... 7.50  
 Hour-A-Day-with-Rider Series—  
 On "Alternating Currents in Radio Receivers"—  
 On "Resonance & Alignment"—On "Automatic  
 Volume Control"—On "D-C Voltage Distribution"  
 90c each

**JOHN F. RIDER PUBLISHER, INC.**  
 404 Fourth Avenue, New York 16, N. Y.  
 Export Division: Roche-International Electric Corp.  
 13 E. 40th Street, New York City Cable: ARLAB

# RIDER MANUALS

GIVE YOU THE HELP YOU NEED!



**"VACO" is the Preference**  
 Shock-proof Break-proof **SCREW DRIVERS** AMBERYL HANDLE

For Signal Corps trainees . . . for a host of other activities in the war effort, Vaco is supplying screw drivers and small tools designed for efficiency, and to speed up work in the radio and electronic field. Over 173 sizes and types. Write for catalog.

Vaco's ability to create special drivers and small tools is aptly illustrated in the panel at left, showing some of our unusual developments.

**VACO Products Company**  
 317 E. ONTARIO ST.  
 CHICAGO 11, ILL.  
 Canadian Branch Warehouse  
 560 King St. W., Toronto

## Radio Jobber Is Irreplaceable

Recognizing the vital distribution functions of the radio parts jobber in providing service and stock-carrying facilities for the dealer, John Meck



John Meck

Industries, radio and parts makers of Plymouth, Ind., have announced a postwar merchandising policy in which distribution only through established jobbers is a cardinal principle.

Highlights of this policy are disclosed in a statement to the trade by John Meck, president, who declares that a careful analysis of postwar distribution problems led to the decision that radio dealers can best be served through jobber channels.

"It was our desire to formulate a irrevocable platform on which could be based our entire postwar merchandising program," Mr. Meck said. "I wanted a program that would insure both consumers and dealers having the best possible service in addition to desirable merchandise.

"After careful study of the field we came to the conclusion that the radio parts jobber holds so irreplaceable a position in the distribution picture that any program which failed to take full cognizance of these facts would not be to the best interests of dealers, consumers or ourselves as manufacturers.

"The stock-carrying and service facilities of radio parts jobbers unquestionably add to convenience and speed with which dealers can conduct their businesses."

The Meck postwar jobber merchandising policy is set forth in a statement published to the trade "without equivocation or reservation." It reads in part:

"Because the jobber has provided and will continue to provide, a vital function in merchandising, we will

continue our policy of sales only to, and through, our recognized jobbers. We pledge that every product leaving our plant will be engineered, produced, packaged and priced as to best conform to the sales needs of our jobbers and dealers. All prices and discounts will be computed on the basis of the costs of intelligent representation by ethically conducted wholesale and retail businesses."

### Continental Changes Its Name to "Admiral Corp."

Adopting the widely known name of its Admiral radio, the Continental Radio and Television Corp. of Chicago recently announced it has officially become the Admiral Corporation.

Organized in 1934, Continental had grown rapidly into an important producer of family radios in peacetime, and is now utilizing double its former plant space and personnel in the production of radio equipment for the armed forces.



President Ross D. Siragusa

"This change of name," according to Ross D. Siragusa, president of Admiral, "is part of the postwar planning we have been doing during the eighth day we manage to squeeze into each week.

"Besides the importance of establishing a product's name, we recognize the value of a sound reputation for the firm that produces it. If both the product and the producer have the confidence of the public, sales will come more easily. We have been advertising the name 'Admiral' extensively, with our budget in 1943 exceeding \$400,000 for radio time and space in national magazines. It is just sound business sense to capitalize on this popularization of the name for the benefit of the corporation, as well as the product. After all, it is easier to establish one name in the public mind than two."

Adopting the new name is just the start of Admiral's postwar planning, Siragusa said.



**PROUD,  
YOU BETCHA!**

"WE'RE PLENTY PROUD of every one of those 207 Burgess employees in the service of Uncle Sam!" says Homer G. Snoopshaw, Burgess specialist. "But how we miss 'em! Even fully staffed, we were hard pressed to turn out *all* the batteries you and Uncle Sam required. Today, we parcel out farm radio packs and Uni-cells as *fairly* as possible... and as extensively as military production permits... And we know you're giving *your* customers the same sort of fair and square distribution."

**BURGESS BATTERY COMPANY, FREEPORT, ILLINOIS**



★ **14<sup>NEW</sup> STANCOR Victory Model**  
**TRANSFORMERS AND CHOKES**  
**ARE NOW AVAILABLE FROM STANCOR JOBBERS!**



If your present supplier is unable to supply your requirements for VICTORY MODEL Transformers and Chokes, contact your nearest STANCOR Jobber today. A nation-wide distribution system is maintained for your convenience. If you don't know your nearest STANCOR jobber, write us.

**STANDARD TRANSFORMER CORPORATION**  
1500 NORTH HALSTED STREET, CHICAGO

# Favorite

The **BEST BET!**

Back the attack—  
Buy more **WAR BONDS**

## FAVORITE'S HOLIDAY MESSAGE To Manufacturers—

Many thanks for your cooperation and service in 1943. All good wishes for 1944.

## To Dealers—

A thousand thanks for your loyal support and patronage in 1943 despite our inability (for reasons beyond our control) to give you the usual efficient FAVORITE service, which we will resume when Victory is ours. All good wishes for 1944.



**THE FAVORITE MFG. CO.**  
105 East 12th Street, New York, N. Y.

## Heads New Department

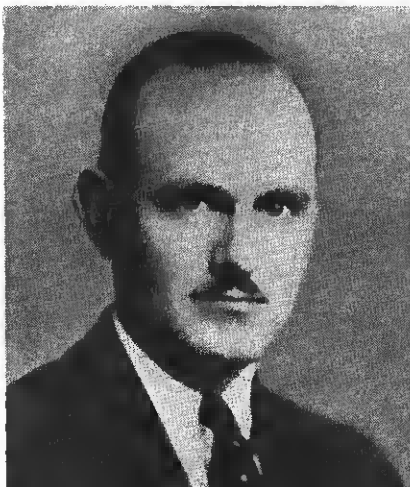

Stanley H. Manson, sales promotion manager and executive secretary Stromberg-Carlson Company's labor-management committee, heads new public relations department.

## Army-Navy "E" Awards

The storage battery division of Philco Corp., Trenton, N. J., has been awarded a second star to add to its "E" flag.

For the third time International Resistance Co., Phila., has been awarded the Army-Navy "E."

## Record Needles Travel

Some of the actual adventures befalling shipments of Recoton Needles read like a Hollywood script. Edward M. Bieber, sales manager of the Recoton Corp., reports that several shipments of needles, dispatched from Switzerland, where Recotons are made, travelled 15,000 miles before reaching New York.

## Radio Service Manager



F. Leo Granger, veteran Stromberg-Carlson man, and former radio retailer, recently appointed service manager for the company.

# RECORDISC

*is back again!*

Those best-selling,  
business-building, profit-making  
home recording blanks are now  
available—WITHOUT PRIORITY!

### WARTIME PRODUCTION

Although materials are limited, and transportation facilities over-taxed, RECORDISC is making every effort to produce the finest home recording blanks and to deliver as fast as possible. Meanwhile, we're looking ahead to a peacetime world when we'll better be able to help build for you a wider and even more profitable market.

### SALES TO JOBBERS ONLY

The RECORDISC policy now, as always, is to sell to jobbers only. If an order is received from a non-jobber, it's turned over to the jobber in that territory who is credited with the order.

### WAR QUALITY

The tone, quality, length of life of these RECORDISCs is the same as in pre-war days. The only difference in these "Victory Discs" is in the non-priority substitute materials.

### WRITE FOR NAME OF LOCAL JOBBER.

Send us a postcard with your name and address, and we'll immediately forward the name of the RECORDISC jobber in your territory.

### WRITE FOR FREE LITERATURE

Effective RECORDISC selling aids will be supplied to you upon request. Now, as ever, we'll back you to the limit with promotional ammunition.



# THE RECORDISC CORP.

395 BROADWAY, NEW YORK 13, N. Y., • CABLE ADDRESS: RECORDISC, NEW YORK, N. Y.

## Philco Sponsors Unique All Hour Program

Conceived with the purpose of creating a series of "Academy Awards" for the first time in radio, a new kind of broadcasting program, "Radio Hall of Fame," presenting the outstanding performers of radio, stage, screen, con-



Philco Official James H. Carmine, left, talks about the big show with Paul Whitman.

entertainment, night club and music fields in a 24 hour of entertainment, is being sponsored by Philco Corp.

The first one of the series of fifty-two Sunday programs was heard on December 5th. The coast-to-coast Blue Network schedule of this series is on from 6 to 7 P. M., EWT., and will originate in a number of large cities throughout the country.

### Presenting Great Name Stars

The "Radio Hall of Fame," according to its sponsors, represents the first time in radio history a new idea to make the airwaves the birth of the quiz type broadcast. The new production will feature the greatest ensemble of global names in the entertainment world. The program for the broadcast is now being developed and selected from the theatre, radio, night club and concert stage, and arrangements are being made so that each act will be audiotaped and hit-proved prior to the show.

### Two Appointed by Browne

Bill Lotz, formerly advertising manager of Sentinel Radio Corp., Evanston, Ill., and more recently on the staff of Wilson & Co., Chicago, has been appointed an account executive for the Brown Advertising Agency, Chicago.

The Browne organization also reports the appointment of Harry O. Horan to its art staff. Mr. Horan was formerly with Campbell-Ewald in Detroit and has been with Montgomery Ward for the past seven years.

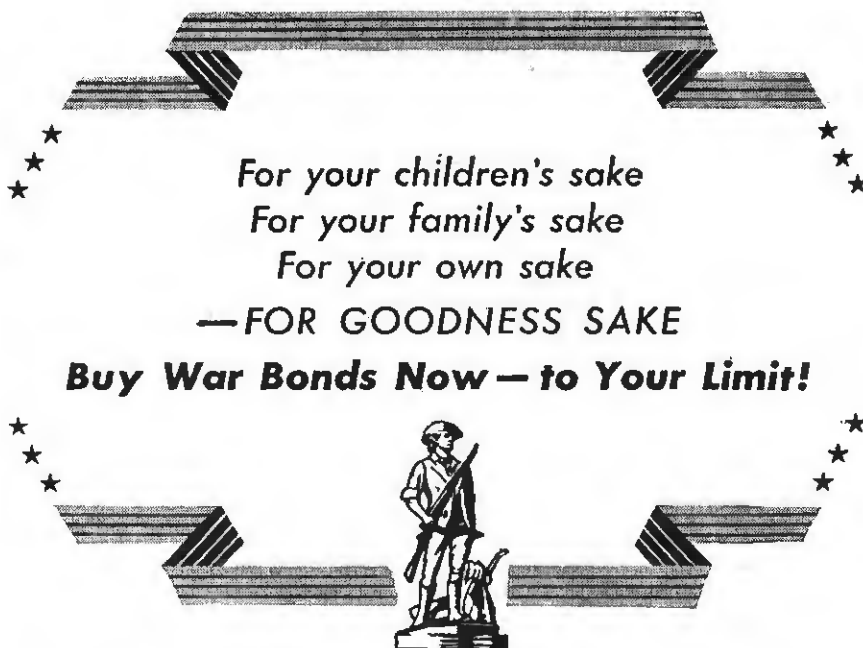

THE RAULAND CORPORATION . . . CHICAGO, ILLINOIS

• *Electroneering is our business* •

# Rauland

RADIO . . . SOUND . . . COMMUNICATIONS



The Same Story...

### With a Sensational Difference

The retreating tread of the Germans across the Russian Battlefields is an echo of Napoleon's retreat in 1814.

But now! The innumerable vaster armies and all the modern equipment of warfare are precisely coordinated and controlled by thousands of applications of modern radio communications and electronics.

Science has turned the ether waves against Hitler for an even more disastrous defeat.

Radio and electronics are contributing mightily to this Victory... and Sentinel has been a major factor in developing and building the radios and electronic equipment which is even now successfully passing the supreme test of battle.

# Sentinel

QUALITY RADIO SINCE 1920  
SENTINEL RADIO CORPORATION  
2020 Ridge Avenue • Evanston, Ill.

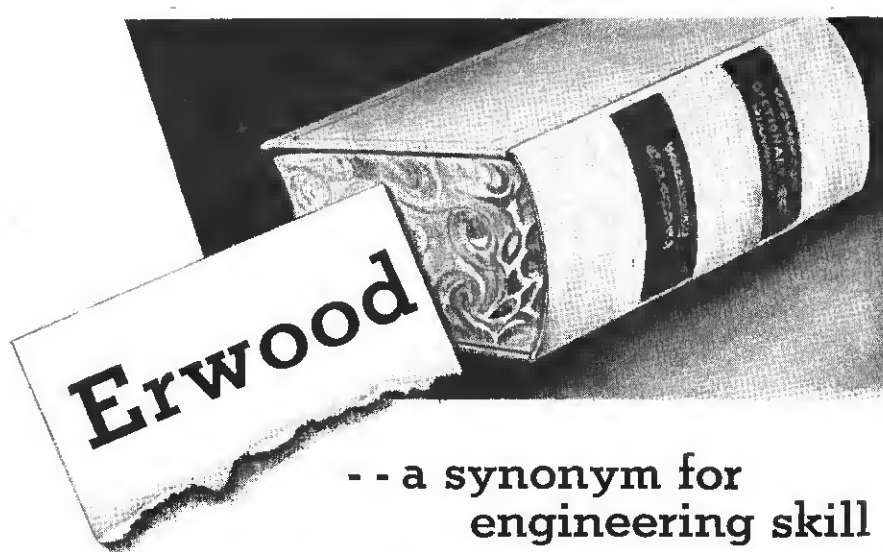

**Erwood**

**-- a synonym for engineering skill**

For over twenty years the name of ERWOOD has stood for high standards in the engineering field.

After Victory—this well experienced organization will be available for the solution of YOUR problems.

**THE ERWOOD COMPANY**  
 225 WEST ERIE STREET CHICAGO, ILLINOIS

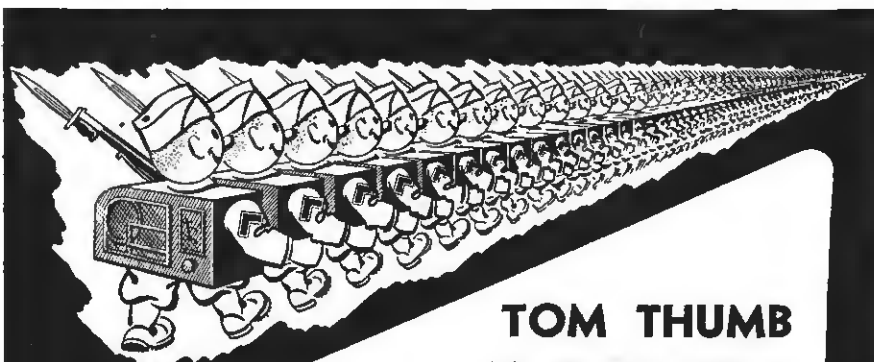

**TOM THUMB IS TURNING FABLE INTO FACT!**

Every hour of every day, hundreds of Tom Thumb workers are bringing to life the spirit of the little man who was known in fable for his marvelous powers. But it's no midget's job here in the Tom Thumb factory. It's "all out," do-your-damndest—TO WIN.

The same marvelous powers that made Tom Thumb radio so famous will go to work FOR YOU just as soon as dealer shipments are again possible. In the meantime—chins up!

Make your plans NOW to get on the TOM THUMB bandwagon

**Automatic**  
 RADIO MANUFACTURING CO., INC.  
 122 Brookline Avenue, Boston, Mass.

(Continued from page 62)

**BINGHAMPTON, N. Y.**—C. E. Alberts advises that custom-built radios are turning up in greater number than usual because customers do not want to send them back to the manufacturer or locate the nearest specialist recommended by the factory. Time was, claims Albert's, when owners of custom-built sets would trust their receivers with any local serviceman, however reliable.

**KENTON, Ohio**—Henry Rexin, head of the Rexin Electric & Furniture Co., isn't overlooking any bets in the postwar planning. He states that the firm is doing its best to maintain contact with its old customers in order that it may be able to go to them with new appliances when peace comes. At present washers, refrigerators and radios are wearing out at a fast pace. Most of the owners will be prospecting for new equipment.

Formerly Frigidaire refrigerator and ranges, water heaters, Philco radios and General Electric and Westinghouse small appliances were merchandised. Today electrical supplies, furniture and service are keeping the home fires burning here, Mr. Rexin pointed out.

**Service Stepped-up**

The service department is busy with jobs from all over Hancock county, of which Kenton is the county seat, and is the center of a rich agricultural region. Local factories are busy with war contracts, and the workers are in the money.

After the war, and as soon as new appliances are available, the home will go after business in an aggressive manner, declares Mr. Rexin.

**ROCHESTER, N. Y.**—A lot has been said about flat rates being practiced in time of war. Reliable Radio Service reports that they have a wartime special—a "tone-up" job for \$3 flat. This includes checking all tubes, making minor repairs and providing a tube, if necessary. Customers must agree to have three "tone-ups" yearly at \$3. per call, and these are at the serviceman's convenience, any time within a two-week period, every four months. The idea is that the service shop keeps its customers during wartime, and has a segment of business it can estimate in advance—especially the time element.



**YRACUSE, N. Y.**— Bartlett recommends installing a line of pocketbooks and wallets. Keeps customers lingering in the shop, and makes them more willing to lug in their sets, because they can take a look at the pocketbooks when they get there, says Bartlett.

**ALTIMORE, Md.**— Popular Radio Co., 1904-06 Greenmount Ave., an important factor in the local radio sales and service fields, which during its sixteen years of business has serviced some 40,000 radios, in addition to the sale of a substantial number of sets, has, because of wartime conditions, supplemented its merchandising activities by the addition of a number of available lines of merchandise, including costume jewelry, leather goods, novelties, toys sporting goods.

The concern, which occupies a three-story structure, has divided its main floor into two parts; the rear half devoted to radio servicing, the front-half to displaying and selling records, and the other supplemental items.

According to Lawrence Frank, proprietor, the double operation is working out very satisfactorily, and makes it possible to do a good business for the duration.

**Alternate Lines**

The steadily growing volume in some of the supplemental items, may, according to present plans, be continued after the war, Mr. Frank said. Costume jewelry is especially big, with sporting goods and leather goods items not far behind in total sales volume. These items, Mr. Frank declared, are good traffic builders, and for no other reason than this, they will be continued.

"Our record operation, now an important factor, is certain to become a companion department of the radio sales activities," Mr. Frank said, adding that "currently, our record volume would be much larger, if we could permit a member of the personnel to give all his time to selling records, but the help shortage makes this impossible.

"Our radio servicing is holding up well, considering the tube and replacement parts supply situation," Mr. Frank said, adding that parts are coming through better than tubes.

**IN 1933**

**HALL OF SCIENCE**  
of Chicago's  
"Century of Progress"  
introduced new wonders  
to the world!

*Since 1895... THORDARSON HAS SET THE PACE FOR DEVELOPMENT OF NEW WONDERS IN THE TRANSFORMER FIELD*

This, in a few words, tells the story of Thordarson leadership. But the reason for that leadership lies in the years of experience, and the constant, untiring devotion of Thordarson engineers to every task... their notable contributions to the war effort being typical of Thordarson's ability to meet the needs of every situation.

**THORDARSON**

TRANSFORMER DIVISION  
THORDARSON ELECTRIC MFG. CO.  
500 WEST HURON STREET, CHICAGO, ILL.

*Transformer Specialists Since 1895*  
**ORIGINATORS OF TRU-FIDELITY AMPLIFIERS**

**WOMAR**

*Manufacturers of*  
**RADIO, ELECTRICAL AND  
ELECTRONIC COMPONENTS**

**ELECTRONIC PRODUCTS MFG. CORP.**  
**DEXTER, MICHIGAN**

DEPENDABLE MUTER PRODUCTS \* DEPENDABLE MUTER PRODUCTS

DEPENDABLE **MUTER** PRODUCTS

Manufacturers  
of Component parts for  
the Radio, Electronic  
and Communications  
Industries . . . .

THE **MUTER** CO.  
1255 South Michigan Avenue  
Chicago, U. S. A.

MUTER PRODUCTS \* DEPENDABLE

MUTER PRODUCTS \* DEPENDABLE

# Radio Retailing TOMORROW

## “Handie” and “Walkie” Sets Seen in Peacetime

The “walkie-talkie,” portable two-way radio, carried on the backs of soldiers, and the “handie-talkie,” which weighs but five pounds, eleven ounces and is ideal for paratroopers for keeping in touch with planes and bases, are seen in peacetime roles also by the Galvin Mfg. Corp., makers of Motorola radios, who are currently doing a big job in supplying the armed forces with radio equipment.

A recent statement by the Galvin Corp., says in part:

“Such development of Army radio, as seen in these portable two-way sets, points to many practical applications for postwar use. Present use of the principle is familiar to all as applied to municipal police and fire departments. But it is too early to make definite predictions. Most applications will probably be industrial and will evolve gradually as industry adjusts itself to peacetime pursuits.

“However, there can be no question but that the technical necessities of war, and the very rapid progress made under stress of urgent war needs, will result in benefits to all as an aftermath of the struggle. It is an ill wind that blows no good as the ancients put it.”

## Philco Plans on Postwar Huge Production Scale

Production and sales of Philco Corp., this year should substantially exceed all previous records, even after very substantial price reductions on Army and Navy work to give the government the benefit of new methods and increasing efficiency, according to James T. Buckley, chairman of the company's executive committee.

“This production record gives some indication of the essential part that the Company has been called upon to play in the war effort,” Mr. Buckley pointed out in a special message to the 20,000 Philco dealers. “But looking ahead to the postwar period, it presents the most direct kind of challenge to every person connected with Philco. For what we should plan to do is not to shrink our organization and facilities to the level of some previous year, but to develop ways and means of using them as fully as they are now being used, with this difference—that whereas they are now devoted to producing the most effective implements of war, they will be turned to the production of useful, desirable commodities for the millions of people who are our customers. In this way also, Philco will make its greatest contribution to the creation of employment opportunities in the postwar period.”

## Sees Future Television Market Looming Large

In a recent talk before the American Television Society and the Advertising Club of New York, Thomas F. Joyce, manager radio, phonograph and television dept., RCA Victor division of Radio Corp. of America, made some interesting comments on the probable rate of market development for television.

Mr. Joyce described the necessity for the investment of millions of dol-



Thomas F. Joyce scans the future and sees a billion dollar industry.

lars in studios and transmitters to be located in key cities, and the huge sums needed to build network facilities and the production of suitable television advertising programs, but stress the point that the answers to the problems would rapidly develop if the biggest problem of all were solved—namely, an *acceptable low cost radio television receiver*.

### \$200 Price Range Favored

Mr. Joyce said that “the conclusion seems inescapable that when, in the postwar period, the radio industry produces a good television receiver in the \$200 price range, a very big percentage of homes of the United States will be ready to buy television receivers as soon as service is available to them.”

After describing in detail all of the problems confronting the situation Mr. Joyce made some interesting predictions on the potential sales market as follows:

“. . . then it would not be unreasonable to assume that within ten years after the full commercialization of television, television service would be available to 23,700,000 wired homes .



### WHEN TOMORROW COMES

and war production needs must no longer have the right of way, you'll be hearing more and more about Vogue electrical products for the home.

Meantime, our full facilities are given over to producing war goods . . . all types of parts and complete units. In our well equipped, versatile plant, we can now handle even more war work, and we welcome inquiries along this line.



**SHERIDAN ELECTRO CORP.**  
2850 S. MICHIGAN AVENUE - CHICAGO 16, ILL.

80% of the wired homes of the United States. This would represent a population of about 100,000,000 people and approximately 82% of the total U. S. buying power. Television industry sales at this point should be, approximately, 3,500,000 units per year for a total retail billing of between six hundred million and seven hundred million dollars (\$600,000,000 and \$700,000,000). This billing, together with replacement tubes for existing receivers, service, transmitter sales, television advertising revenue, etc., will make television the billion dollar industry that many have prophesied it will be."

### Majestic Sees Radio-Phonograph Demand

As the result of a nation-wide contest sponsored by Majestic Radio & Television Co., Chicago, a number of interesting postwar buying trends are being visualized by officials of the company. A portion of a recent official statement is as follows:

"Foremost among the public's wants is a radio-phonograph combination instrument. and in the preponderance of cases the families interviewed added . . . and we will insist upon F. M. (Frequency Modulation) too."

"We were impressed with the public's attitude, as expressed to us by dealers, toward television . . . in most instances they are aware that television reception may not be widely available immediately after the war, and only ask that manufacturers be frank and candid in any announcements made," said E. A. Tracey, president of Majestic Radio.

### Alter Issues Booklet On Postwar Jobber Plans

An attractive booklet, "A Distributor Makes Post-War Plans," has recently been issued to customers by the Harry Alter Co., radio and appliance jobbers, 1728 So. Michigan Ave., Chicago. The booklet is illustrated with drawings and photographs.

A portion of the introduction to the booklet reads as follows:

"As soon as hostilities cease and all of us are able to return to civilian pursuits, it is the intention of The Harry Alter Company to resume its place as a leading distributor of major appliances in the Chicago territory. Dominant lines of radios, refrigerators, home laundry equipment and associated merchandise will be contracted for, as soon as is practicable. This booklet, therefore, is to remind all of our friends, both old and new, that when the time arrives for the resumption of appliance selling on an aggressive scale this old established, financially sound, experienced and alert organization will play a leading part in serving the needs of both manufacturers and dealers."



## Tougher Than Ever..

### Greenohm POWER RESISTORS

★ Yes, tougher than ever. That's the reason why those green-colored cement-coated Clarostat Greenohms are found in more and still more quality instruments and fine assemblies. Try a Greenohm for yourself. Subject it to your own test. Then draw your own conclusion.

Quality resistance wire accurately wound and critically tensioned on heat-proof ceramic tube, and imbedded in cold setting inorganic cement.

Wire remains unimpaired in production process, since no elevated temperatures are applied to set the coating.

10 and 20-watt fixed; adjustable, up to 200-watt.

Maximum heat dissipation. 300% overload without breakdown.

Choice of mountings, terminals, taps, adjustable sections, sliding contact bands, etc.

★ Send us your resistor or control problems. Engineering data on request. Let Clarostat solve that problem.



CLAROSTAT MFG. CO., Inc. • 285-7 N. 6th St., Brooklyn, N. Y.

## University



### REFLEX SPEAKERS

now the accepted **STANDARD** for all **WAR USE**

**EVERY UNIVERSITY REFLEX** the result of years of pioneering research and development.

### EVERY HIGH EFFICIENCY SPEAKER

in University's extensive line of power speech reproducers has a vital part to play in the WAR program.

### REMEMBER

University is now producing many special speakers for the Army, Navy & Signal Corps. Submit your special problem direct to the engineering dept.

UNIVERSITY LABS., 225 VARICK ST., NYC

## Remember ALLIANCE Phono-motors?

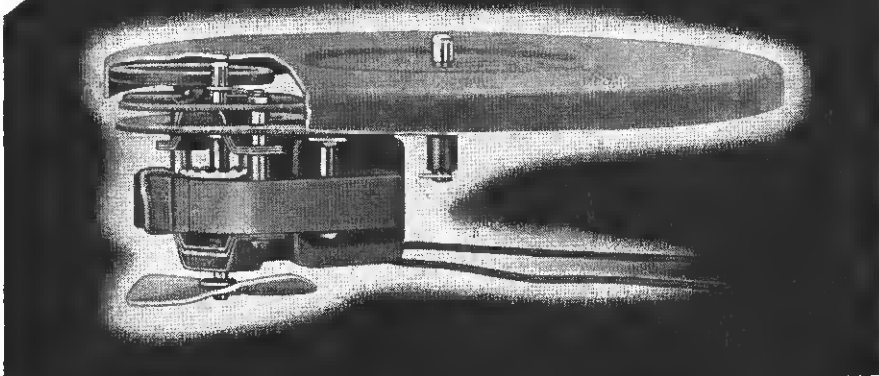

### Good News! ALLIANCE Resumes Production on One Standard Model

● We are now able to return to production of one standard variation of Alliance Model 80 Phono-motor, according to the following definite specifications and on the production plan explained below.

**STANDARD SPECIFICATION No. 811—Turntable No. Y-278-S2; 110 Volt, 60 cycle, 9" Model 80**

Production must be on the following practical basis under present conditions where there are no large volume priority orders—namely, by accumulating a sufficient quantity of small orders with necessary priority and making periodical single production runs at such time as the quantity of accumulated orders is enough to make this practical. Priority orders (currently AA-5 or higher) must allow delivery time required to obtain a minimum practical production run; to procure material for all orders in hand, and make one production run of the one type standard unit only, for shipment on the various accumulated orders. ● Check the above against your requirements, and if you have proper priority, communicate with us.

**REMEMBER ALLIANCE—Your Ally in War as in Peace!**

**AFTER THE WAR IS WON, WE WILL TELL YOU ABOUT SOME NEW AND STARTLING IDEAS IN PHONO-MOTORS**

**ALLIANCE MANUFACTURING COMPANY  
ALLIANCE, OHIO**



*Parts  
by*  
**Centralab**

Div. of Globe-Union Inc., Milwaukee, Wis.

- Steatite Insulators
- Ceramic Trimmers
- High Frequency Circuit Switches
- Volume Controls
- Ceramic Capacitors
- Wire Wound Controls
- Sound Projection Controls

## Ros R. Howard New Capitol Records Vice-President

B. G. (Buddy) De Sylva announces the appointment of Ros R. Howard as vice president of Capitol Records Distributing Company.

Buddy De Sylva, a power in musical comedy and now executive producer of Paramount Pictures, is a co-founder of Capitol Records, Inc.,



Ros R. Howard will supervise national distribution of records for Buddy De Sylva organization.

along with the song-writer and singer, Johnny Mercer, and Glenn Wallichs of Hollywood.

Mr. De Sylva announces that Mr. Howard will have charge of all branch operations and supervise the national distribution of Capitol Records. Ros Howard is well known in the trade, having been secretary of the Howard Radio Co. in the old neutrodyne days, later becoming general manager of Zenith Radio's Chicago branch, and for several years prior to joining Capitol was president of RCA Victor Distributing Co. in Chicago.

### Sometimes the Customer Isn't Right, He Discovers

Radioman Ed Peterson, Brooklyn N. Y., ran into this one. A customer brought in a table model radio, saying: "This set came from out of the country, and was given to me as a present. It's a DC set. I tried it and it won't play on AC current. I have been to several repair shops with it, and all said they were either too busy to change it over for me, or that it would cost more than I would care to pay."

Peterson, however, didn't take the customer's statements for granted like the other fellows did. He examined the set, and found that it was actually an AD-DC receiver. Checking it over carefully, he discovered that the reason it wouldn't play was because someone had put the 35Z5 tube in the 50L socket and the 50L tube in the 35Z5 socket.

# ESICO

REG. U. S. PAT. OFF.

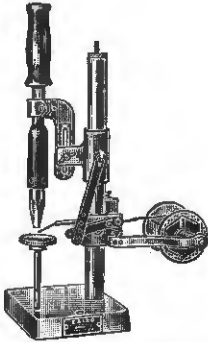

**SPOT SOLDERING MACHINE**  
designed for treadle operation for advancement of iron and solder, leaving operator's hands free for handling of product.



**SOLDERING IRONS**

are widely used in industrial plants throughout the country. They are designed to withstand the strain of continuous service required of factory tools.

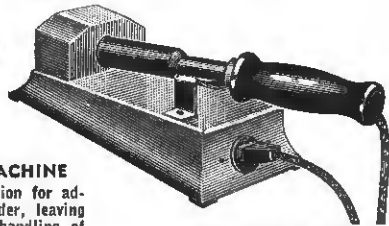

**SOLDERING IRON TEMPERATURE CONTROLS**  
prevent overheating of soldering irons between soldering operations. Irons do not deteriorate when being used. The idle period causes oxidation and shortens life.

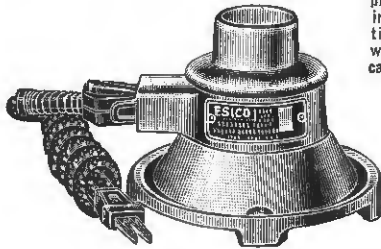

**SOLDER POTS**  
ruggedly constructed pots of various sizes designed for continuous operation and so constructed that they are easily and quickly serviced, should elements have to be replaced.

*Write for Catalog*

**ELECTRIC SOLDERING IRON CO., INC.**  
2312 WEST ELM STREET, DEEP RIVER, CONN.

FOR YOUR REPUTATION'S SAKE  
*Sell Genuine*  
**XCELITE**  
SCREWDRIVERS



... with the transparent, shock-proof handles originated by Xcelite

Xcelite started the "new era of screwdrivers"—the eye-appealing, easier-to-use, longer lasting screwdrivers with the clear, shock-proof handles of Xcelite special plastic. Today Xcelite Screwdrivers are the standard of comparison, imitated but not excelled! In addition to their famous handles, Xcelite Screwdrivers are known for their high quality blades, accurately machined. Here are the ideal tools for electrical, mechanical and general use. Over 50 sizes and styles, square and round blades. Available on satisfactory priority ratings. Details and prices on request. Write Dept. M.

**PARK METAL WARE CO., INC.**  
ORCHARD PARK BUFFALO, N. Y.



QUALITY TOOLS  
PREFERRED BY THE EXPERTS

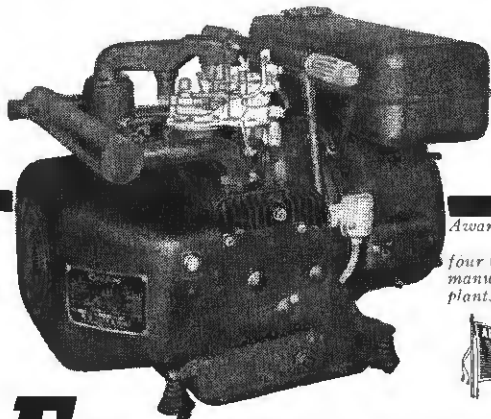

*Awarded to  
four Onan  
manufacturing  
plants.*



## **ELECTRICITY** *For Any Job Anywhere*

★ ONAN GASOLINE DRIVEN ELECTRIC GENERATING PLANTS provide electricity where power lines are not available, and for emergency service.

They're doing a war winning job on all the fighting fronts generating electricity for vital communications work and other war tasks.

Sizes from 350 to 35,000 watts, 50 to 800 cycles, 110 to 660 volts, A.C.—6 to 4000 volts, D.C. Also dual A.C. and D.C. output models.

Your inquiry regarding present or post-war needs will receive prompt attention.

**D. W. ONAN & SONS**  
2014 Royalston Ave., Minneapolis, Minn.

**ONAN**  
ELECTRIC PLANTS

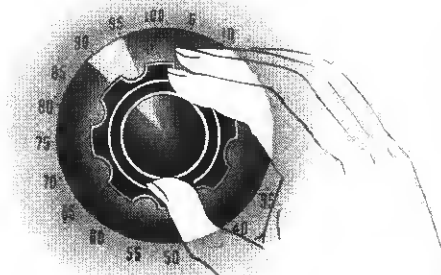

## **MONARCH** Testing-Measuring Instruments . . .

for the laboratory and for the production line, are speeding production now, as never before, due to their exceptional accuracy and dependability.

Our testing instruments are regularly specified by many manufacturers for shipment with other equipment as government contracts require. If you need assistance along any of the lines mentioned we invite you to consult us without any obligation.

**MONARCH MFG. CO.**  
2014 N. Major Ave. Chicago, Ill.

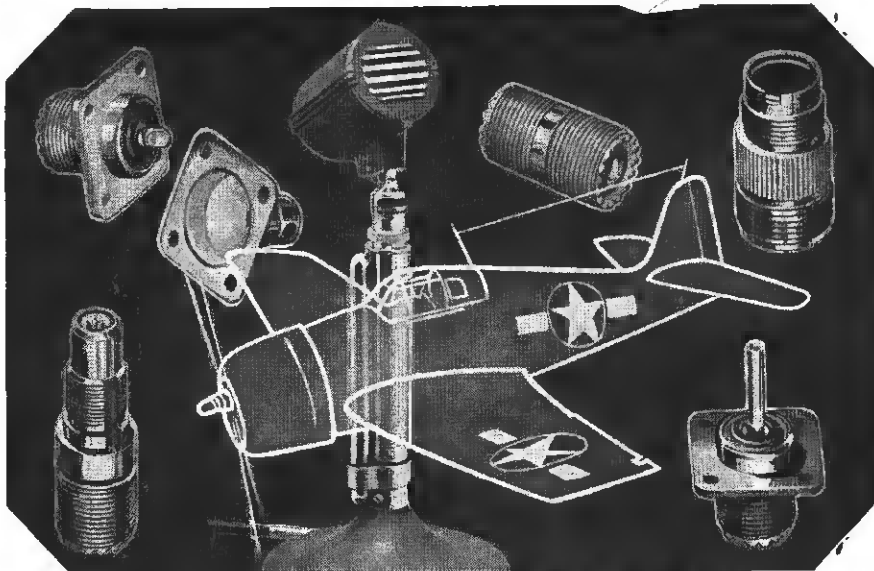

## PRODUCING AND PLANNING

Because of the extreme care and precision exercised in their manufacture and the high standard of their operating efficiency, Astatic Co-axial Cable Connectors are being exclusively used and highly praised by many leading manufacturers of wartime radio communications equipment. Equal honors are being shared by Astatic's GDN Series Dynamic Microphones with grip-to-talk control, now being manufactured and used extensively in many branches of the service. Astatic continues to build for the present and plan for the future.

**ASTATIC**

IN CANADA:  
CANADIAN ASTATIC, LTD.  
TORONTO, ONTARIO

**THE ASTATIC CORPORATION**  
YOUNGSTOWN, OHIO

## Joins Emerson Radio Staff

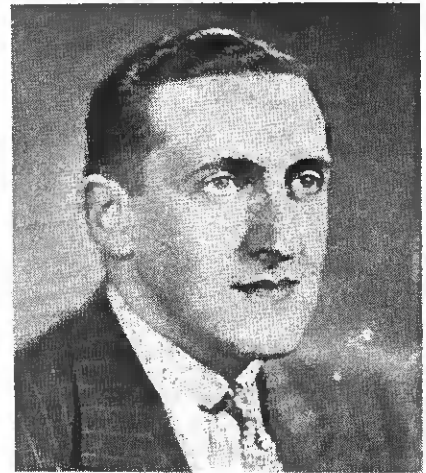

Robert C. Berner, recently resigned from the WPB, now serves Emerson Radio & Phonograph Corp., as assistant to President Ben Abrams.

## Detrola and Machine Tool Company Vote to Merge

Stockholders of International Machine Tool Corp., approved recently at a special meeting at Elkhart, Ind., a proposal to merge Detrola Corp., Detroit radio manufacturer, now producing electronic devices for the Army and Navy, into International under the name "International Detrola Corporation."

Detrola stockholders voted in favor of the proposal at a recent meeting in Detroit. The merger is expected to become effective December 31.

Detrola employs about 1,350 persons. Their prewar products included portable and home radios, record changers and car radios. International has machine tool plants in Elkhart and Indianapolis, and a welding division in South Bend. It has about 1,200 employees, and makes military automotive parts in addition to lathes and superfinishing machines, which were also the company's peacetime products.

As stipulated in the merger, the first officers of International Detrola Corp. will be: C. Russell Feldmann, president and chairman of the board; Charles H. Foster and Warren J. Hannum, vice-presidents; John Hancock, treasurer; Harry E. Hamilton, secretary and assistant treasurer; R. L. Dillon, assistant secretary and controller. Directors listed are: John Ballantyne, C. Russell Feldmann, Charles H. Foster, John Hancock, Warren J. Hannum, D. M. S. Hegarty and Frank A. Willard.

## J. F. Pedder Is Promoted

J. F. Pedder, formerly assistant advertising manager of the appliance division of Frigidaire, has been appointed advertising and sales promotion manager. This division includes refrigerators, electric ranges and water heaters.

**LET'S LOOK**  
*at the Record...*

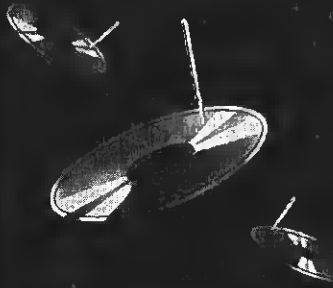

FROM A PERFORMANCE STANDPOINT, Recoton Needles have a remarkable record... high fidelity reproduction without surface noise... and an amazing gentleness that protects the finest records.

FROM A MERCHANDISING STANDPOINT, Recoton Needles have an equally fine record... packaged for rapid selling at all times... foremost in consumer acceptance and continued profitable repeat business. As always, Recoton Needles set the Standard.

ALWAYS FAITHFUL  
**RECOTON**  
NEEDLES

RECOTON CORP. LONG ISLAND CITY, N. Y.

For a  
**Merry**  
**Christmas**  
give War  
**Bonds &**  
**Stamps**

**PEERLESS  
ALBUM**

**WHEN  
A  
RECORD  
NEEDS  
A  
FRIEND**

*the  
best of  
Good Wishes  
for you in 1944  
from Peerless*

Watch for the announcement early in 1944 of the new Peerless expanded quarters. New address—more room—but always the same Peerless Quality.

*Peerless*  
**Album Co., Inc.**  
38-44 W. 21st St., New York, N. Y.

**CUTTING HOLES  
IN RADIO  
CHASSIS?**

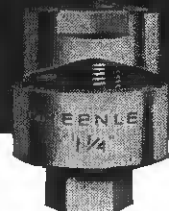

**Save Time  
with  
GREENLEE  
PUNCHES**

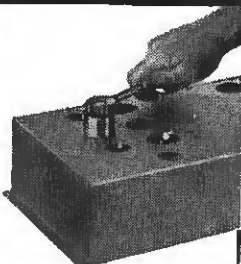

① **No Drilling** — Making small holes larger without drilling is a simple task with Greenlee Punches. Holes as small as  $\frac{3}{16}$ " are enlarged in a jiffy with a few turns on the cap screw.

② **No Reaming** — Range of sizes from  $\frac{1}{8}$ " to  $2\frac{1}{4}$ " cut accurate holes—eliminate reaming. Knockout Punches up to  $3\frac{1}{2}$ " size are also available.

③ **No Filing** — Die supports the metal and tool cuts clean, smooth holes fast and easy — leaves no ragged edges.

**WRITE FOR CATALOG 33E**

Find out how these and other Greenlee Tools can save you time. They are available for essential users. Write for Catalog No. 33E.

**GREENLEE TOOL CO.**  
1912 Columbia Ave., Rockford, Ill.

**"Pete" Boucheron  
Promoted in The Navy**

Former Farnsworth sales manager, "Pete" Boucheron was promoted to the rank of captain recently while overseas.

"Pete" served in the Navy during World War I, and retained his status in the United States Naval Reserve un-



Former Lieutenant Commander . . . now a Captain overseas!

til he was called back in 1941, as a Lieutenant Commander. His new rank of captain in the Navy is comparable to that of a colonel in the Army.

**JFD Belt and Ballast Guide  
Is Just Issued**

The new 1944 edition of the J.F.D. Belt and Ballast Book consisting of 96 pages is just off the press.

It contains valuable information regarding replacement woven fabric belts for over 1500 different radio sets and over 2200 different replacement ballasts with schematic diagrams to-

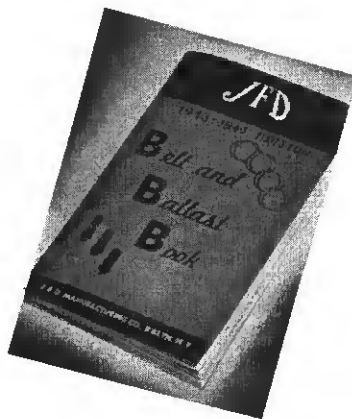

**Information-filled Book**

gether with data covering battery harness, battery plugs, line cord adapters, etc.

It is given free to the serviceman or dealer for the return of 10 belt envelopes or 10 coupons (1 enclosed in each belt envelope) by J.F.D. Mfg. Co., 4111 Ft. Hamilton Parkway, Brooklyn (19), N.Y.

**DUMONT**

**OIL-FILLED  
Ceramic  
SEALED**

**CAPACITORS**

*For  
Dependable  
Service  
Work*

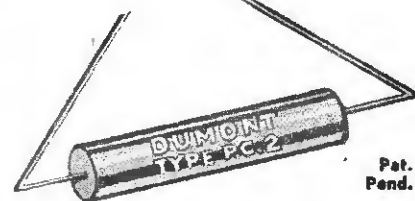

Pat.  
Pend.

- For long life in repairs for those expensive high-class service jobs on amplifiers, public address, police and school systems and all good electronics equipment.

All capacitors from .0001 to .25 from 600 volts to 2000 volts.

It is  
your duty  
to buy  
war bonds

Literature and prices  
on request

**DUMONT  
ELECTRICO.**

MEMBER OF  
CAPACITORS FOR EVERY REQUIREMENT

34 HUBERT STREET  
NEW YORK, N. Y.

*Superior*  
**ANTENNAE**  
 AND ASSOCIATED PRODUCTS

**IN WAR**

**IN PEACE**

**SNYDER**  
 MANUFACTURING CO.  
 PHILADELPHIA, U. S. A.

**AEROPOINT**  
 "111"

*Long-Life*  
**PHONOGRAPH**  
**NEEDLE**  
*Up to 3000 Plays*  
**\$1.00**

**AERO**  
 NEEDLE COMPANY  
 737 N. MICHIGAN  
 CHICAGO 11, ILL.

## Dealer Answers \$64 Question

Samuel H. Cohen, owner of Sanco Radio Shop, 220 So. Pulaski Road, Chicago, made an initial investment of \$300 last April and laid in a stock of novelties. Now his inventory of these items runs to over \$1,200.

When asked about the possibility of his being stuck with a lot of novelty articles after the war, Mr. Cohen had an answer—and an original one. He plans to use them as gifts with the purchase of radio receivers and other appliances.

"Obviously when the war ends," says Mr. Cohen, "there is going to be a mad rush for radios and all the other appliances that have been curtailed. Radio dealers will be doing a volume of business that will surpass any previous levels. With my left-over stock of novelties I intend to get a head start by actually giving some of these away free with each purchase of a radio or a similar piece of merchandise. After victory, my intentions are to build up a larger clientele than I ever had before, and I believe that there is nothing better than giving away souvenirs.

"In my future advertisements, I

will stress this free gift offer, and the novelties will help me to build up my business."

### Tips on Giftware Selling

Of course, Sanco Radio Shop is very busy with repairs and is doing about \$1,200 a month in service. But the alternate selling items are doing well too.

These items, consisting of dolls, bric-a-brac, lamps, flower pots, etc., he found he could easily obtain, which was a point in their favor. Then this line of merchandise lends itself excellently to his location, as well as to the class of people the store serves. Main feature of this shop is its unusually large display window, enabling anyone passing to see exactly what is within.

Mr. Cohen pointed out the most important factor governing the sales of novelties when he asserted that display is paramount. "Unless a dealer has a comparatively large display window where nearly all merchandise may be seen from the street, I would caution him against entering the novelty line. These items are bought on appearance, and without

### FLASHES OF ACTION FOR TELEVISION FANS

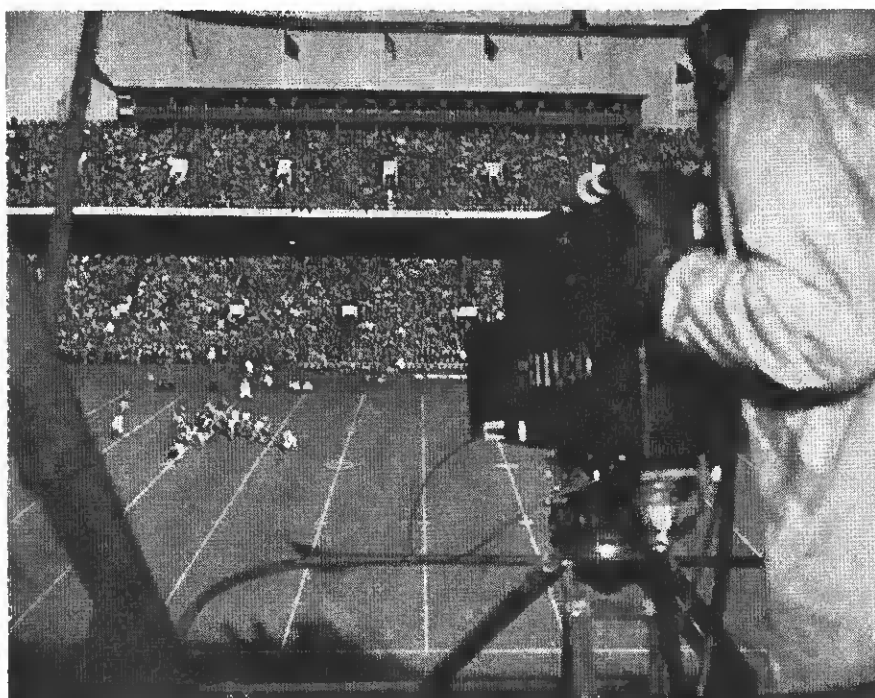

Marking 4th year of football television, Philco Station WPTZ camera at Franklin Field, Philadelphia, covers the Penn-Cornell Game



# DELIVERY? RATING?

HERE'S THE INFORMATION ON THESE SIGNAL PRODUCTS



TELEGRAPH AND WIRELESS INSTRUMENTS

112-K

In addition to our government contracts for Wireless and Telegraph Instruments we have a factory stock of most all of these items for immediate shipment on orders with AA-5 or higher rating.

*If you are not getting our weekly factory stock list send for your copy*

## SIGNAL Portable Electric Drills

OB-8 light duty 1/4", OB-4 standard duty 1/4", and OB-5 standard duty 1/2" . . . are obtainable on A-9 or higher rated orders.



OB-4

**SIGNAL ELECTRIC MFG. CO.**

MENOMINEE, MICHIGAN

Offices in all principal cities

**SIGNAL**

HERE'S

# The ANSWER TO THE RESISTANCE LINE CORD PROBLEM!

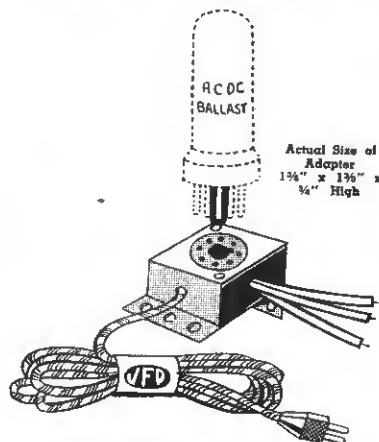

Actual Size of Adapter  
1 3/8" x 1 3/8" x 3/4" High

## JFD RESISTANCE CORD REPLACEMENT ADAPTERS

Resistance line cords, for replacement in AC-DC Radio sets, are now practically impossible to get. New JFD Adapters permit easy substitution of standard ballast tubes FROM YOUR OWN STOCK. Only 4 different numbers of Adapters take place of all types of resistance line records.

Write for Literature

**JFD Mfg. Co.**

4111 Ft. Hamilton Pkwy. Bklyn. 19, N. Y.

any previous decision on the part of the customer. This is why prominent display of the novelty line is most essential."

The items the shop handles range from a dollar to ten dollars.

Records are another line helping the Sanco Radio Shop to remain in business. Although Mr. Cohen is finding it increasingly difficult to procure sufficient recordings, the line nevertheless is operated on a paying basis. Miss Helen Fay is the capable manager of the record department.

It is interesting to note the layout of this shop. At one side is the radio repair department which is handled by Mr. Cohen himself. Tubes are tested at this point and radios received for over-hauling. At the opposite side, against the wall, is the record department. Both departments have circular counters, creating a modern effect. The space between the two sections displays the novelty merchandise, on tables and stepshelves. The interior is completely finished in square celotex with rounded corners. Renovation work was done two years ago when the Sanco Shop moved here from a previous location nearby.

## Sylvania Adds 18th Plant

A five-story building in a central location in Williamsport, Pa., is soon to be converted to the production of electronic manufacturing and testing equipment for Sylvania Electric Products, Inc., according to an announcement made by officials of the company. The new establishment is the 18th plant of the company.

## David T. Siegel Honored



President-founder of Ohmite Mfg. Co., Chicago, made board member, Illinois Institute of Technology.



## Throat Microphones

For Aircraft Inter-Communication systems and radio telephone applications. These microphones open an entirely new field for industrial communications, allowing the wearer to make use of both hands without hampering his other movements. Ideal for use in noisy surroundings where communications must be made by use of headphones.

Model T-30 with CD-318 extension cord and switch, for U. S. Army Radio circuits, now available to priority users through local radio jobbers.

Write for Catalogue No. 961

**UNIVERSAL MICROPHONE CO., LTD.**

INGLEWOOD, CALIFORNIA

CANADIAN DIV: 560 KING ST. WEST, TORONTO 2  
FOREIGN DIV: 301 CLAY, SAN FRANCISCO 11, CAL.

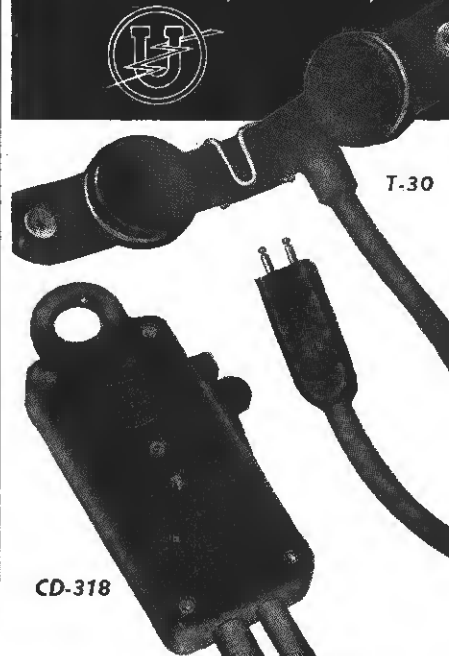

T-30

CD-318



Christmas 1943, our third war Christmas—even in these troubled times it works its magic! On this day we cannot help but think of the boys that won't be here, the fellows that we worked with, laughed with and fought with, of the grand friends of our industry who are scattered around the globe. And we know that, wherever they are, that old familiar greeting, "MERRY CHRISTMAS" will ring in the air.

\* \* \* \*

Christmas is a part of what we are fighting for, more than just a tradition;—it is a basic philosophy of life for which men have fought and bled and died—as they are fighting and bleeding and dying today.

\* \* \* \*

What is this philosophy, first voiced by a poor homeless wanderer, proclaimed to the world by penniless fishermen, whose followers were persecuted by the mighty rulers of their time, and that still dominates the thinking of the truly great nations of the world today?

\* \* \* \*

Just seven words—flaming down through twenty centuries—**PEACE ON EARTH, GOOD WILL TOWARD MAN.**

\* \* \* \*

And to all of you, wherever you are, a **MERRY CHRISTMAS AND A VICTORIOUS NEW YEAR!**

*Klein Stankiewicz*  
**QUAM-NICHOLS CO.**  
 Cottage Grove and 33rd Place  
 Chicago 16, Illinois



### "Reps" NEDA Hold Joint Meeting

A combined dinner and meeting was recently held at the Olds Hotel, in Lansing, Michigan, sponsored by the Wolverine Chapter "Representatives" and The Michigan Chapter National Electronic Distributors Association. Distributors from Detroit, Pontiac, Flint, Saginaw, Muskegon, Grand Rapids, Kalamazoo, Lansing, Jackson and Ann Arbor attended. Matters pertaining to postwar planning were discussed.

#### News of Other Chapters

R. T. Perron was elected chairman of the New England Chapter at a recent meeting. His address is 80 Davenport Street, Taunton, Mass. Vice-chairman of the chapter is T. Coakley of 11 Beacon Street, Boston, Mass., and the secretary is H. Gerber of 94 Portland Street, Boston 14, Mass.

F. A. Emmet was recently elected a member of the Los Angeles Chapter. His address is 2837 West Pico Blvd., Los Angeles 6, Calif.

Another representative has replaced his sample case with a gun. He is J. Maquire of the Mid-Lantic Chapter, Philadelphia, who has joined the armed forces.

B. Whan has recently moved to 679 N. Wells Street, Chicago, Illinois.

(Continued from page 23)

of My Blue Eyes" and sings it on Victor Record No. B-9032. Other popular records by this artist are "West of Rainbow Trail" (No. B-8983), "Streamlined Yodel Song" (B-8696), and "You Are My Sunshine" (No. B-8491).

Victor's Texas Jim Robertson has an album of his own (No. P84) which includes such old favorites as "Home On The Range," "The Cowboy's Dream," and "O Bury Me Not On The Lone Prairie." This album retails at \$2.50, and is a real addition to any record collection.

Not to be overlooked in your promotion of "westerns" is Ferde Grofe's music in album form (The Grand Canyon Suite), Charles Wakefield Cadman's "From The Land of The Sky-Blue Water," "By The Waters of the Minnetonka," etc.

## INDEX

### To Advertisers

	Page
AERO NEEDLE CO. ....	90
AEROVOX CORP. ....	66
ALLIANCE MFG. CO. ....	86
ASTATIC CORP. ....	88
AUTOMATIC RADIO MFG. CO., INC. ....	82
BELL SOUND SYSTEMS, INC. ....	77
BELMONT RADIO CORP. ....	35
BLUE NETWORK, THE ....	6
BURGESS BATTERY CO. ....	79
CENTRALAB ....	86
CHICAGO NOVELTY CO. ....	75
CITY RADIO CO. ....	77
CLAROSTAT MFG. CO., INC. ....	85
CONTINENTAL RADIO & TELEVISION CORP. ....	1
CROSLLEY CORP. ....	59
DECCA DISTRIBUTING CORP. ....	Cover
DELCO RADIO DIV., GENERAL MOTORS CORP. ....	10
DUMONT ELECTRIC CO. ....	89
ELECTRIC SOLDERING IRON CO., INC. ....	87
ELECTRONIC PRODUCTS MFG. CORP. ....	83
ELECTRO-VOICE MFG. CO., INC. ....	33
EMERSON RADIO CORP. ....	12, 13
ERWOOD CO. ....	82
FADA RADIO & ELECTRIC CO., INC. ....	7
FARNSWORTH TELEVISION & RADIO CORP. ....	45
FAVORITE MFG. CO. ....	30
FONDA CORP. ....	70
GAROD RADIO CORP. ....	61
GENERAL ELECTRIC CO. ....	49
GREENLEE TOOL CO. ....	89
HAMMARLUND MFG. CO., INC. ....	39
HOFFMAN RADIO CORP. ....	31
HYTRON CORP. ....	5
INTERNATIONAL RESISTANCE CO. ....	69
JACKSON ELECTRICAL INSTRUMENT CO. ....	68
JENSEN RADIO MFG. CO. ....	71
JFD MFG. CO. ....	91
KEN-RAD TUBE & LAMP CORP. ....	72
MAGNAVOX CO. ....	55
MAJESTIC RADIO & TELEVISION CORP. ....	48, 48A
MALLORY & CO., INC., P. R. ....	Cover
MEISSNER MFG. CO. ....	63
MONARCH MFG. CO. ....	87
MUTER CO. ....	84
NATIONAL UNION RADIO CORP. ....	43
ONAN & SONS, D. W. ....	87
PARK METALWARE CO., INC. ....	37
PEERLESS ALBUM CO., INC. ....	89
PERMO PRODUCTS CORP. ....	76
PHILCO CORP. ....	29
QUAM-NICHOLS CO. ....	92
RAULAND CORP. ....	81
RAYTHEON PRODUCTION CORP. ....	11
RCA VICTOR DIV. ....	57, 65
RADIO CORP. OF AMERICA. ....	80
RECORDISC ....	88
RECOTON CORP. ....	78
RIDER PUBLISHER, INC., JOHN F. ....	47
ROLA CO., INC. ....	Cover
SEEBURG CORP., J. P. ....	81
SENTINEL RADIO CORP. ....	85
SHERIDAN ELECTRO PRO. ....	91
SIGNAL ELECTRIC MFG. CO. ....	67
SIMPSON ELECTRIC CO. ....	90
SNYDER MFG. CO. ....	3
SPRAGUE PRODUCTS CO. ....	2, 79
STANDARD TRANSFORMER CORP. ....	14
STROMBERG-CARLSON CO. ....	74
SUPREME INSTRUMENTS CORP. ....	8
SYLVANIA ELECTRIC PRODUCTS, INC. ....	83
THORDARSON ELECTRIC MFG. CO. ....	41
TRIPLETT ELECTRICAL INSTRUMENT CORP. ....	91
UNIVERSAL MICROPHONE CO., LTD. ....	85
UNIVERSITY LABS. ....	48C
U. S. TREASURY ....	37
UTAH RADIO PRODUCTS CO. ....	78
VACO PRODUCTS CO. ....	4
WFRSTER ELECTRIC CO. ....	73
WESTON ELECTRIC INSTRUMENT CORP. ....	27
WILCOX GAY CORP. ....	9
ZENITH RADIO CORP. ....	9

While every precaution is taken to insure accuracy, we cannot guarantee against the possibility of an occasional change or omission in the preparation of this index.

# Decca

RECORDS



## LESS THAN A MONTH OLD . . . . AND HEADED FOR AN ALL-TIME HIGH

*Porgy & Bess* . . . *This Is The Army* . . . *Holiday Inn* . . . Each was an impressive Decca "original-cast" album — each piled up an important sales record over the course of a year or more. Then *Oklahoma!* stepped out and in only a month's time has taken command. There has never, in the history of recording, been such demand for an album!

Decca already had a reputation for its "original-cast" albums. *Oklahoma!* merely strengthens that reputation — and establishes Decca for all time as your primary source of popular records — the records most people want. If, at the moment, you can't get all the albums you can use, please be patient. We are meeting an overwhelming demand to the best of our ability.

ALL THESE HITS FROM THE  
THEATRE GUILD MUSICAL PLAY  
ARE IN  
DECCA ALBUM A-359

- ★
- OKLAHOMA OVERTURE
- FINALE
- OH, WHAT A BEAUTIFUL MORNIN'
- OKLAHOMA
- THE SURREY WITH THE FRINGE ON TOP
- ALL ER NOTHIN'
- KANSAS CITY
- OUT OF MY DREAMS
- I CAIN'T SAY NO
- PORE JUD IS DAID
- MANY A NEW DAY
- PEOPLE WILL SAY WE'RE IN LOVE



# DECCA

## DISTRIBUTING CORPORATION





# Seeburg

FINE MUSICAL INSTRUMENTS SINCE 1902

AT THIS SEASON, THOUGHTS TURN TO THOSE  
SERVING OUR COUNTRY, AT HOME AND ABROAD,  
THEY HAVE PLACED EVERY ONE OF US DEEPLY  
IN THEIR DEBT, FOR ALL THAT IS PRECIOUS IN  
AMERICA'S HERITAGE, INCLUDING THE IDEALS  
WHICH CHRISTMAS ITSELF BEST EXPRESSES. IS  
HOMAGE; IN THEIR VALIANT KEEPING . . . TO THEM, OUR  
MAY THE NEW YEAR BRING VICTORY TO THEIR  
ARMS AND PEACE AND JOY TO ALL THE WORLD.

J. P. SEEBURG CORPORATION  
CHICAGO, ILLINOIS